



THE NEW GENERATION OF FINISH & TRIM TOOLS



15^{GA}
DA **TN51P1P**
2½" ANGLED FINISH NAILER

18^{GA}
BRAD **BN31M1P**
2½" BRAD NAILER



18^{GA}
L **LS61H1P**
¼" CROWN, 1½" FINISH STAPLER



16^{GA}
STRAIGHT **TN41P1P**
2½" FINISH NAILER



23^{GA}
PIN **TN11G1P**
1⅜" HEADLESS PINNER



OIL-LESS DESIGN
Routine lubrication is not required

SWIVEL PLUG
For added maneuverability

ERGONOMIC OVERMOLDED GRIP
Reduces fatigue and increases control of the tool

ALUMINUM MAIN BODY
Durable and lightweight

NO-MAR PAD
Protects the worksurface from being scratched or damaged, extra no-mar pad included

TABLE OF CONTENTS

See all tools and fasteners located on pages 84-89



DURASPIN® Auto-Feed Screw Systems

DS225-18V, DS222-18V, DS322-18V	3
DS245-AC, DS242-AC, DS342-AC	4
DS230-S1, DS230-M1, DS230-D1, DS230-D2	5
DS530 Series, DS532-AC, DS534-AC	6
SG2510, SG4100	7
Collated Screws	8-11
Screw System Accessories	12-13



Finish & Woodworking

F-18XP, F-16XP, F-15XP, F-LXP	15
TN11G1, TN11L1, TN11G1P	16
TN21L1, LS1XP, BN31M1P, FinishPro18Mg	17
FinishPro18BMg, SLP20XP, FinishPro25XP, TN41P1P	18
FinishPro30XP, TN51P1P, FinishPro42XP	19
SLS20XP, SLS25XP, SKSXP	20
SLS150Mg, LS61HIP	21
SC1XP Senclamp, SC2 Sencor	22
Fasteners	23-29



Framing, Sheathing & Subfloors

F-35XP, F-35FRHXP	31
FN91T1, FN81T1	32
FramePro325XP, FramePro701XP, FramePro751XP	33
FramePro325FRHXP, FramePro702XP, FramePro752XP	34
SCN60XP, SCN65XP, Mini Hand Nailer, A20 Hand Nailer	35
JN91H1, JN91H2, JN91P1, JN91P2	36
SCP40XP, PS15XP, PS20XP	37
NS20XP, NS20BXP, SNS41, SQS55XP	38
Fasteners	39-47



Roofing, Siding & Fencing

RoofPro445XP, SN71P1	49
PS15RXP, BC58, A11	50
Fasteners	51-53



Pallets & Crating

PalletPro57FXP, PalletPro100XP, PalletPro130XP	55
DFPXP, F75LXP, F75SXP	56
Fasteners	57-59



Upholstery & Furniture

SFT10XP Family	61
SFW09, NS20BXP	62
Fasteners	63-65



Flooring

SFH200, SLS20XP-HF	67
Fasteners	68



Air Compressors

PC1131, PC0968, PC1280, PC1010, PC1010N, PC0947	71
---	----



Accessories

Air Hoses	73
Plugs & Couplers, Swivel Plugs & Swivel Couplers	74
Air Hose & Compressor Accessories, Regulators & Gauges	75
Oils & Lubricants, Safety Glasses & Tool Belt Hooks, Extended Length Magazines	76
Battery & Charger Systems, No-Mar Pads	77
Parts Kits	78



Product Reference

Fastener Finish Types	79
Item Code Index	80-83
Reference	84-89

DURASPIN® AUTO-FEED SCREW SYSTEMS

DURASPIN® **PRODUCTIVITY REDEFINED**

DURASPIN® screw systems help you get the job done up to four times faster than bulk screwdrivers and loose screws, improving jobsite productivity by more than 30%.

APPLICATIONS

Our full line of integrated tools, attachments, kits, and accessories can tackle almost any job including drywall, sub-flooring, decking, metal framing, and a variety of commercial and industrial applications. For projects with tough requirements, our wide selection of ICC and Miami-Dade certified screws will keep your job on target. Check out our next generation of DURASPIN® auto-feed screw systems with enhanced features that redefine productivity and help you get the job done faster and easier.

KEY FEATURES

- Patented corner-fit feed system for better screw placement in tight spaces and corners
- Locking depth-of-drive adjustment
- Tool-free adjustable nosepiece
- Easily load 50 screws in less than a second
- Trigger lock for continuous operation
- Long-lasting drive bits with quick-slide release

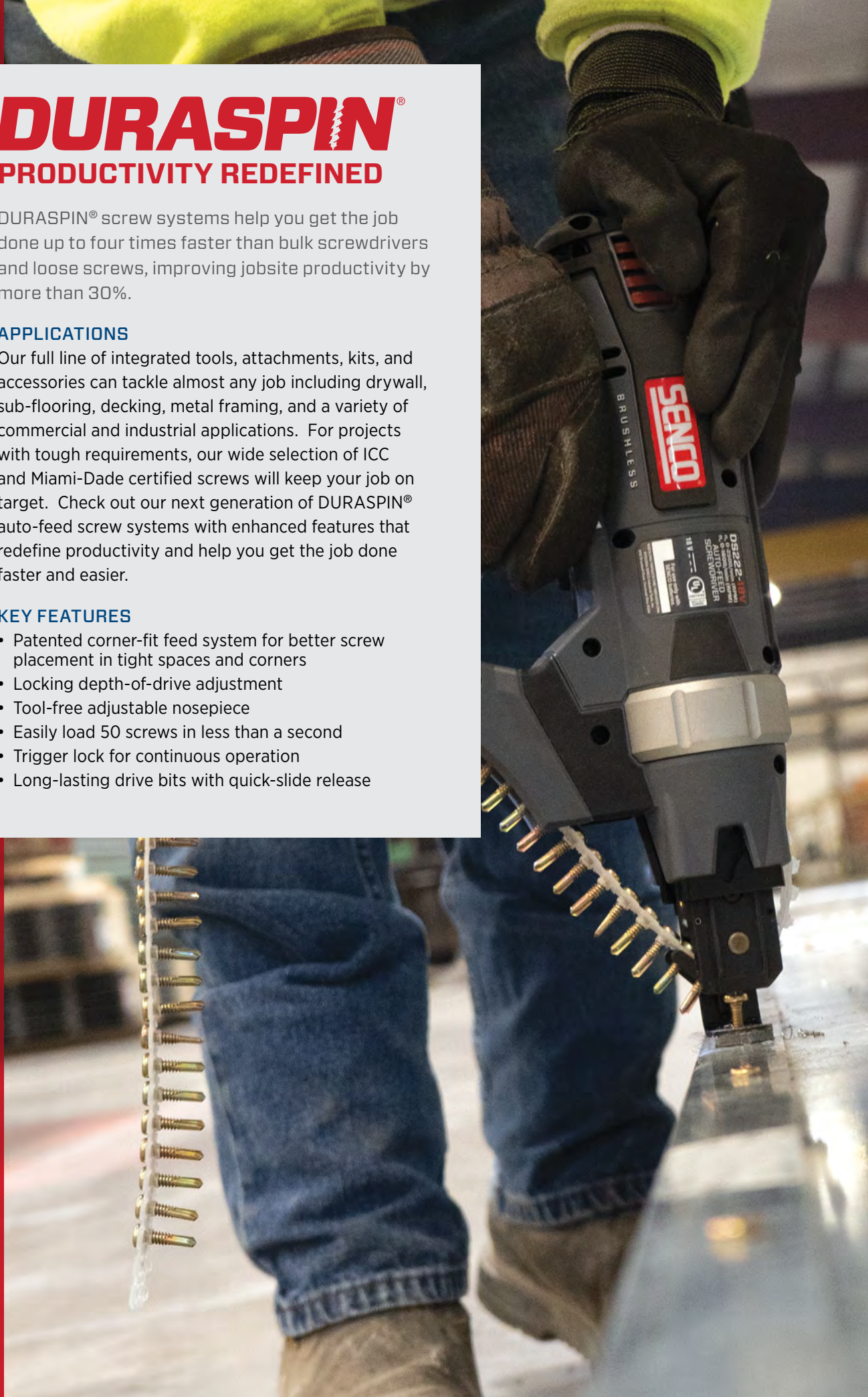

DS225-18V

2" CORDLESS 18V LI-ION 5000 RPM

ITEM #10A0002N



5000 RPM/TPM

BRUSHLESS MOTOR

2 bits included



Features

- High-speed, efficient brushless motor designed for drywall applications
- Features feed on return - the next screw is aligned with the bit for better line of sight and more accurate screw placement
- Patented corner fit technology
- Includes 2 bits, 1 x 4.0 Ah Li-ion battery, quick charge battery charger and storage bag

PRIMARY APPLICATIONS

High Speed Applications Including Drywall to Wood or Light Steel

SECONDARY APPLICATIONS

Subfloor, Sheathing, Cement Board, Underlayment

DS222-18V

2" CORDLESS 18V LI-ION 2500 RPM

ITEM #10B0002N



2500 RPM/TPM

BRUSHLESS MOTOR

2 bits included



Features

- Selectable 2500/1600 RPM efficient brushless motor
- Features feed on return - the next screw is aligned with the bit for better line of sight and more accurate screw placement
- Patented corner fit technology
- Includes 2 bits, 1 x 4.0 Ah Li-ion battery, quick charge battery charger and storage bag

PRIMARY APPLICATIONS

High Torque Applications Including Metal Framing/Decking

SECONDARY APPLICATIONS

Crating, Gypsum/Sheathing to Steel, Decking, Subfloor

DS322-18V

3" CORDLESS 18V LI-ION 2500 RPM

ITEM #10C0002N



2500 RPM/TPM

BRUSHLESS MOTOR

2 bits included



Features

- Selectable 2500/1600 RPM efficient brushless motor
- Toe nailing nosepiece
- Variable speed selector for heavy steel
- Features feed on return - the next screw is aligned with the bit for better line of sight and more accurate screw placement
- Includes 2 bits, 1 x 4.0 Ah Li-ion battery, quick charge battery charger and storage bag

PRIMARY APPLICATIONS

General Applications Including Wood Decking, Tile Roofing, Crating

SECONDARY APPLICATIONS

Decking, Docks, Crating, Gypsum/Sheathing to Steel, Tile Roofing

DURASPIN Auto-Feed Cordless Screwdrivers

Productivity Redefined

- Patented corner-fit feed system
- Detachable feed system to expose bit for quick reversing
- Precise depth of drive adjustment with depth lock
- Quick slide button bit change
- Universal toe-nailing nosepiece
- Powered by 18V Li-Ion extended life battery
- Quick charge battery charger
- Tool-free screw length adjustment
- Variable speed trigger with lock and reverse
- Adjustable belt hook



Product Reference Chart

TOOL SPECS	DS225-18V	DS222-18V	DS322-18V
Speed (RPM)	0-5000	0-1600, 0-2500 (Selectable)	0-1600, 0-2500 (Selectable)
Voltage	18V	18V	18V
Weight w/ Battery	5.1 lbs (2.3 kg)	5.3 lbs (2.4 kg)	5.4 lbs (2.5 kg)
Height	9.6" (244 mm)	9.6" (244 mm)	9.6" (244 mm)
Length	13.7" (348 mm)	13.7" (348 mm)	14.5" (368 mm)
Width	3.4" (86.4 mm)	3.4" (86.4 mm)	3.4" (86.4 mm)
Warranty	5 yr	5 yr	5 yr
FASTENER SPECS	Collated screws are located on pages 8-11		
Range	1"-2"*	1"-2"*	1"-3"
Shank Diameter	#6 - #8	#6 - #12	#6 - #12
TOOL FEATURES			
Depth-of-Drive	Yes	Yes	Yes
Reversible Belt Hook	Yes	Yes	Yes
Trigger	Variable with Lock	Variable with Lock	Variable with Lock
Power Type	Cordless	Cordless	Cordless
Reversible	Yes	Yes	Yes

* 1/2" - 2" with nosepiece sold separately

DS245-AC

2" CORDED 5000 RPM

ITEM #10D0001N



5000 RPM/TPM

2 bits included



Features

- High-speed motor designed for drywall applications
- Corner-fit feed system
- Feed on return
- Includes 2 bits and carrying bag

PRIMARY APPLICATIONS

Drywall to Wood, Drywall to Light Steel, Underlayment, Cement Board

SECONDARY APPLICATIONS

Subfloor, Wood Decking

DS242-AC

2" CORDED 2500 RPM

ITEM #10E0001N



2500 RPM/TPM

2 bits included



Features

- High-torque motor for driving into dense material
- Corner-fit feed system
- Feed on return
- Includes 2 bits and carrying bag

PRIMARY APPLICATIONS

Metal Framing, Cement Board

SECONDARY APPLICATIONS

Drywall to Wood, Drywall to Steel, Subfloor, Underlayment, Wood Decking, Composite Decking

DS342-AC

3" CORDED 2500 RPM

ITEM #10F0001N



2500 RPM/TPM

2 bits included



Features

- High-torque motor for driving into dense material
- Corner-fit feed system
- Feed on return
- Includes 2 bits and carrying bag

PRIMARY APPLICATIONS

Wood Decking, Composite Decking, Sheathing to Steel

SECONDARY APPLICATIONS

Drywall to Wood, Drywall to Steel, Subfloor, Underlayment, Metal Framing, Cement Board

DURASPIN® Auto-Feed Coded Screwdrivers

Productivity Redefined

- Patented corner-fit feed system
- Precise depth of drive adjustment with depth lock
- Quick slide button bit change
- Universal toe-nailing nosepiece
- Tool-free screw length adjustment
- Variable speed trigger with lock and reverse
- Screw-strip guide
- Adjustable belt hook
- Heavy duty 10' power cord



Product Reference Chart

TOOL SPECS	DS245-AC	DS242-AC	DS342-AC
Speed (RPM)	0-5000	0-2500	0-2500
Current (Amps)	6.0	6.0	6.0
Voltage	120V/60Hz	120V/60Hz	120V/60Hz
Weight	5.5 lbs (2.5 kg)	5.7 lbs (2.6 kg)	6.7 lbs (3.0 kg)
Height	9.7" (246 mm)	9.7" (246 mm)	9.7" (246 mm)
Length	16.3" (417 mm)	16.4" (417 mm)	17.2" (437 mm)
Width	3.2" (81 mm)	3.2" (81 mm)	3.2" (81 mm)
Warranty	5 yr	5 yr	5 yr
FASTENER SPECS	Collated screws are located on pages 8-11		
Range	1"-2"*	1"-2"*	1"-3"
Shank Diameter	#6 - #10	#6 - #12	#6 - #12
TOOL FEATURES			
Depth-of-Drive	Yes	Yes	Yes
Reversible Belt Hook	Yes	Yes	Yes
Trigger	Variable with Lock	Variable with Lock	Variable with Lock
Power Type	Corded	Corded	Corded
Reversible	Yes	Yes	Yes

* 1/2" - 2" with nosepiece sold separately

DS230-S1

2" AUTO-FEED SCREWDRIVER ATTACHMENT

ITEM # #9Z0001N

2 bits included



COMPATIBLE WITH:
SENCO®
SELECT MODELS

For Senco Models:

- SG2510
- SG4100

PRIMARY APPLICATIONS

Drywall (Into Wood or Steel Studs)

SECONDARY APPLICATIONS

Metal Framing, Sheathing, Cement Board

DS230-M1

2" AUTO-FEED SCREWDRIVER ATTACHMENT

ITEM #9Z0021N

2 bits included



COMPATIBLE WITH:
MAKITA®
SELECT MODELS

For MAKITA Models:

- FS2200
- FS2500
- FS4200
- FS6200
- XSF03
- XSF04
- XSF05

PRIMARY APPLICATIONS

Drywall (Into Wood or Steel Studs)

SECONDARY APPLICATIONS

Metal Framing, Sheathing, Cement Board

DS230-D1

2" AUTO-FEED SCREWDRIVER ATTACHMENT*

ITEM #9Z0011N

2 bits included



COMPATIBLE WITH:
DeWALT®
SELECT MODELS

*Includes Adaptor

For DeWALT Models (Corded):

- DW252
- DW253
- DW255
- DW257
- DW266
- DW272
- DW276

PRIMARY APPLICATIONS

Drywall (Into Wood or Steel Studs)

SECONDARY APPLICATIONS

Metal Framing, Sheathing, Cement Board

DS230-D2

2" AUTO-FEED SCREWDRIVER ATTACHMENT

ITEM #9Z0012N

2 bits included



COMPATIBLE WITH:
DeWALT®
SELECT MODELS

For DeWALT Models (Cordless):

- DCF620
- DCF630

PRIMARY APPLICATIONS

Drywall (Into Wood or Steel Studs)

SECONDARY APPLICATIONS

Metal Framing, Sheathing, Cement Board

DURASPIN 2" Auto-Feed Screwdriver Attachments

Convert a standard screwdriver into an auto-feed screw system in seconds

- Patented corner-fit feed system
- Feed on return functionality to improve speed and reliability of drives
- Universal nosepiece for drywall and wood applications
- Easily remove attachment to access bit
- Tool-free screw length adjustment
- Supports several screwdriver models
- Precise depth of drive adjustment with depth lock



Product Reference Chart

TOOL SPECS	DS230-S1	DS230-M1	DS230-D1	DS230-D2
Weight	1.3 lbs (.59 kg)	1.3 lbs (.59 kg)	1.3 lbs (.59 kg)	1.3 lbs (.59 kg)
Height	5.5" (140 mm)	5.5" (140 mm)	5.5" (140 mm)	5.5" (140 mm)
Length	11.0" (280 mm)	11.0" (280 mm)	10.8" (274 mm)	10.3" (262 mm)
Width	2.5" (64 mm)	2.5" (64 mm)	2.5" (64 mm)	2.5" (64 mm)
Warranty	5 yr	5 yr	5 yr	5 yr
FASTENER SPECS	Collated screws are located on pages 8-11			
Range	1"-2"	1"-2"	1"-2"	1"-2"
Shank Diameter	#6 - #12	#6 - #12	#6 - #12	#6 - #12
TOOL FEATURES				
Depth-of-Drive	Yes	Yes	Yes	Yes



DS530 Series

3" AUTO-FEED SCREWDRIVER ATTACHMENT KIT

ITEM #10X0002N | #10X0012N | #10X0022N



Features

- Feed On Return
- Patented Sliding Screw Guide
- Corner-Fit Feed System
- Quick Release Clamp
- Extension Pole
- Adjustable Depth-of-Drive with Depth Lock

APPLICATIONS

Sheathing, decking, underlayment, sub-flooring, steel decking, drywall, cement board, rigid foam insulation

DS530-S1 (10X0002N)
for SENC0 Models:

- SG2510 • SG4100

DS530-D1 (10X0012N)
for DeWalt Models:

- DW252 • DW253 • DW255
- DW257 • DW266 • DW272
- DW276 • DCF624

DS530-M1 (10X0022N)
for MAKITA Models:

- FS2200 • FS2500 • FS4200
- FS6200 • XSF03 • XSF04
- XSF05

DS532-AC

3" ATTACHMENT KIT WITH 2500 RPM SCREWDRIVER

ITEM #10X0003N



2500
RPM/TPM

3 bits included



Features

- 3-in-1 Tool Kit
- Feed On Return
- Patented Sliding Screw Guide
- Corner-Fit Feed System
- Quick Release Clamp

APPLICATIONS

Wood and Composite Decking, Cement Board, Sub-Flooring and Underlayment, Sheathing to Steel, Steel Decking, Drywall to Wood or Steel

DS534-AC

3" ATTACHMENT KIT WITH 4000 RPM SCREWDRIVER

ITEM #10X0013N



4000
RPM/TPM

3 bits included



Features

- 3-in-1 Tool Kit
- Feed On Return
- Patented Sliding Screw Guide
- Corner-Fit Feed System
- Quick Release Clamp

APPLICATIONS

Sub-Flooring, Underlayment, Wood and Composite Decking, Cement Board, Drywall to Wood, Drywall to Steel

Product Reference Chart

TOOL SPECS	DS530 SERIES
Weight	3.4 lbs. (1.5 kg)
Height	3.5" (89 mm)
Length	33" (838 mm)
Width	2.75" (70 mm)
Warranty	5 yr
FASTENER SPECS	Collated screws are located on pages 8-11
Range	1"-3"
Shank Diameter	#6 - #12
TOOL FEATURES	
Depth-of-Drive	Yes

Additional screwdrivers, bits and adaptors sold separately — see page 12

Product Reference Chart

TOOL SPECS	DS532-AC	DS534-AC
Speed (RPM)	0-2500	0-4000
Current (Amps)	6.5	6.5
Weight	7 lbs. (3.2 kg)	7 lbs. (3.2 kg)
Height	7" (178 mm)	7" (178 mm)
Length	40.5" (1029 mm)	40.5" (1029 mm)
Width	2.75" (70 mm)	2.75" (70 mm)
Warranty	5 yr	5 yr
FASTENER SPECS	Collated screws are located on pages 8-11	
Range	1"-3"	1"-3"
Shank Diameter	#6 - #12	#6 - #12
TOOL FEATURES		
Depth-of-Drive	Yes	Yes
Belt Hook	Yes	Yes
Trigger	Variable with lock	Variable with lock
Power Type	Corded	Corded
Reversible	Yes	Yes

SG2510

HIGH-PERFORMANCE 2500 RPM SCREWDRIVER

ITEM #6X0002N



2500
RPM/TPM

2 bits included



Features

- High-torque motor for driving into dense materials
- Industrial-grade metal gear housing designed to sustain heavy usage
- Great for all-day use with ergonomic, lightweight and compact design
- Trigger lock for continuous operation
- Industrial-grade 10' cord
- Includes 2 bits (as shown)

PRIMARY APPLICATIONS

Composite Decking, Wood Decking, Cement Board, Sheathing to Steel, Metal Framing

SECONDARY APPLICATIONS

Drywall to Wood, Drywall to Steel, Subfloor, Underlayment

SG4100

HIGH-PERFORMANCE 4000 RPM SCREWDRIVER

ITEM #6X0004N



4000
RPM/TPM

2 bits included



Features

- High-speed motor designed for drywall applications
- Industrial-grade metal gear housing designed to sustain heavy usage
- Great for all-day use with ergonomic, lightweight and compact design
- Trigger lock for continuous operation
- Industrial-grade 10' cord
- Includes 2 bits (as shown)

PRIMARY APPLICATIONS

Drywall to Wood, Drywall to Steel, Subfloor, Underlayment, Cement Board

SECONDARY APPLICATIONS

Wood Decking

Nosepieces and drive bits for every application:

drywall, wood, metal and metal channel.



Product Reference Chart

TOOL SPECS	SG2510	SG4100
Speed (RPM)	0-2500	0-4000
Current (Amps)	6.5	6.5
Weight	3.6 lbs (1.6 kg)	3.4 lbs (1.5 kg)
Height	7.5" (191 mm)	7.5" (191 mm)
Length	12.5" (318 mm)	12" (305 mm)
Width	2.5" (64 mm)	2.5" (64 mm)
Warranty	5 yr	5 yr
TOOL FEATURES		
Depth-of-Drive	Yes	Yes
Belt Hook	Yes	Yes
Trigger	Variable with Lock	Variable with Lock
Power Type	Corded	Corded
Reversible	Yes	Yes

Drywall to Wood Screws



Sharp point drywall screws for fastening interior drywall to wood

Finish: Gray Phosphate				
		#2 Phillips	Bugle	Sharp
Gauge	Length	Thread	Quantity	Item Code
6	1/4"	Coarse	1000 Tub	06A125P
6	1/4"	Coarse	4000 Box	06A125PB
6	1/2"	Coarse	1000 Tub	06A162P
6	1/2"	Coarse	4000 Box	06A162PB
7	2"	Coarse	1000 Tub	07A200P
8	2 1/2"	Coarse	1000 Box	08A250PK

Finish: Exterior				
Gauge	Length	Thread	Quantity	Item Code
6	1 1/2"	Coarse	1000 Tub	06A162W

Drywall to Light Steel Screws

Sharp point, double thread drywall screws for fastening interior drywall to light-gauge metal studs

Finish: Gray Phosphate					
		#2 Phillips	Bugle	Sharp	
Gauge	Length	Thread	Quantity	Item Code	
6	1/4"	Double Thread	1000 Tub	06B125P*	
6	1/4"	Double Thread	4000 Box	06B125PB*	
6	1/2"	Double Thread	1000 Tub	06B162P*	
6	1/2"	Double Thread	4000 Box	06B162PB*	
6	2"	Double Thread	4000 Box	06B200PB*	

Gypsum to Heavy Steel Screws

Drywall screws with self-drilling point for fastening drywall or gypsum sheathing to heavy-gauge metal studs

Finish: Clear Zinc					
		#2 Phillips	Bugle	Drill	
Gauge	Length	Thread	Quantity	Item Code	
6	1/4"	Fine	4000 Box	06C125CB*	
6	1/2"	Fine	4000 Box	06C162CB*	
6	2"	Fine	4000 Box	06C200CB*	

Finish: Exterior					
Gauge	Length	Thread	Quantity	Item Code	
6	1/4"	Fine	1000 Box	06C125WK*	
6	1/2"	Fine	1000 Box	06C162WK*	
8	3"	3/8 Fine	1000 Box	08C300WK	

Finish: Gray Phosphate					
Gauge	Length	Thread	Quantity	Item Code	
6	1/4"	Fine	4000 Box	06C125PB*	
6	1/2"	Fine	4000 Box	06C162PB*	
6	2"	Fine	4000 Box	06C200PB*	

*ICC certified test data available on all highlighted items. Refer to ESR-4826 for details.

Wood to Wood Screws



General purpose interior wood screws

Finish: Yellow Zinc				
		#2 Square	Flat	Sharp
Gauge	Length	Thread	Quantity	Item Code
8	1 1/2"	Coarse	1000 Tub	08F150Y
8	1 3/4"	3/8 Coarse	1000 Tub	08F175Y
8	2"	3/8 Coarse	1000 Tub	08F200Y
8	2 1/2"	3/8 Coarse	800 Tub	08F250Y
8	2 1/2"	3/8 Coarse	1000 Box	08F250YK
8	3"	3/8 Coarse	800 Tub	08F300Y

Finish: Yellow Zinc				
		#2 Square	Flat	Type 17
Gauge	Length	Thread	Quantity	Item Code
8	1 1/4"	Coarse	4000 Box	08L175YB

Finish: Clear Zinc				
		#2 Square	Flat Head + Nibs	Type 17
Gauge	Length	Thread	Quantity	Item Code
8	1 1/4"	Coarse	4000 Box	08L125CBLCTS

Interior wood screws for harder-engineered lumber and flooring materials

Finish: Yellow Zinc				
		#2 Square	Trim Head + Nibs	Sharp
Gauge	Length	Thread	Quantity	Item Code
8	2"	High Low	4000 Box	08F200YBTHSS

General purpose interior wood screws and subfloors

Finish: Yellow Zinc				
		Rex	Flat	Type 17
Gauge	Length	Thread	Quantity	Item Code
8	1 1/2"	Double	1000 Box	08F150YTK
8	1 3/4"	2/3 Double	1000 Box	08F175YTK
8	2"	2/3 Double	1000 Box	08F200YTK

08F175YTK Double Thread Subfloor Screw



- Type 17 point and double thread design reduces installation time while improving holding power
- Our Rex drive provides smooth engagement with high torque transmitting capability
- Flathead for stronger holding power

COLLATED SCREWS

Wood to Heavy Steel Screws



Pilot point screws for fastening sheathing to heavy steel

Finish:
Clear Zinc



Gauge	Length	Thread	Quantity	Item Code
8	2"	Fine	1000 Box	08G200CKLFPS*

Wing drill point screws for fastening sheathing to heavy steel

Finish:
Clear Zinc



Gauge	Length	Thread	Quantity	Item Code
8	1 5/8"	Fine	1000 Tub	08G162CTWFWFS*
10	1 5/8"	Fine	1000 Box	10G162CTWFWFS*

Finish:
Exterior



Gauge	Length	Thread	Quantity	Item Code
#8	2"	Fine	1000 Tub	08G200WTWFWFS*
#8	2 1/2"	Fine	1000 Tub	08G250WWK*

Low profile screw head for fastening sheathing to steel

Finish:
Clear Zinc



Gauge	Length	Thread	Quantity	Item Code
8	1"	Fine	4000 Box	08G100CBWFDS
10	1 1/2"	Fine	4000 Box	10G125CBWFDS

Wing drill point screws for fastening sheathing to heavy steel structures

Finish:
Yellow Zinc



Gauge	Length	Thread	Quantity	Item Code
12	1 3/4"	Fine	1000 Box	12G175YKLFAX*

Wing drill point screws for fastening sheathing to heavy steel structures

Finish:
Yellow Zinc



Gauge	Length	Thread	Quantity	Item Code
12	2"	Fine	1000 Box	12G200YKLF CX*
12	2 1/2"	Fine	1000 Box	12G250YKLF CX*



08G250WWK Wing drill point screw

- Finish exceeds 1000 hours salt spray testing per ASTM B117

Wood to Light Steel Screws



Sharp point screws for fastening sheathing to light steel

Finish:
Clear Zinc



Gauge	Length	Thread	Quantity	Item Code
8	1 1/2"	Double	1000 Tub	08G150CTLDSS

Cement Board Screws

Screws for fastening cement board or Hardie® board to wood

Finish:
Exterior



Gauge	Length	Thread	Quantity	Item Code
8	1 1/4"	High Low	1000 Tub	08T125W
8	2"	High Low	1000 Tub	08T200W

Screws for fastening cement board or Hardie® board to steel studs

Finish:
Exterior



Gauge	Length	Thread	Quantity	Item Code
8	1 1/2"	Fine	4000 Box	08T150WBWFD S

Decking and Dock Screws

Exterior wood screws for projects such as decks, tile roofing, fencing, siding and docks

Finish:
Exterior

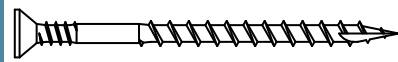

Gauge	Length	Thread	Quantity	Item Code
8	1 1/4"	3/8 Coarse	1000 Tub	08D175W
8	2"	3/8 Coarse	1000 Tub	08D200W**
8	2 1/2"	3/8 Coarse	800 Tub	08D250W**
8	2 1/2"	3/8 Coarse	1000 Box	08D250WK**
8	3"	3/8 Coarse	800 Tub	08D300W**
8	3"	3/8 Coarse	1000 Box	08D300WK**

Finish:
Stainless 304



Gauge	Length	Thread	Quantity	Item Code
8	2 1/2"	3/8 Coarse	800 Tub	08D250S
9	3"	3/8 Coarse	800 Tub	09D300S

Underlayment Wood to Wood Screws

Finish:
Gray Phosphate

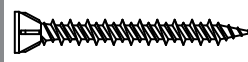

Gauge	Length	Thread	Quantity	Item Code
7	1"	High Low	4000 Box	07Q100PB

Gray Phosphate #2 Square

7	1 1/4"	High Low	4000 Box	07Q125PBQ
---	--------	----------	----------	-----------



** Approved for use in Miami-Dade County FL.

Composite Decking Screws



Trim head screws for fastening composite decking to wood

Finish:
Exterior

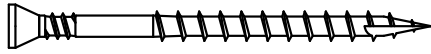

#2 Square Trim Type 17

Gauge	Length	Thread	Quantity	Item Code
8	2½"	¾ Coarse	800 Tub	08R250W
8	3"	¾ Coarse	800 Tub	08R300W

Specially designed cup head screws eliminate mushrooming around screw head after installation

Finish:
Exterior/Gray

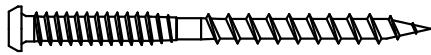

#2 Square Cupped Pan Sharp

Gauge	Length	Thread	Quantity	Item Code
8	2½"	Multi-Thread	800 Tub	08S250W003

Finish:
Exterior/Tan

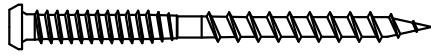

Gauge	Length	Thread	Quantity	Item Code
8	2½"	Multi-Thread	800 Tub	08S250W592

Finish:
Exterior/Brown

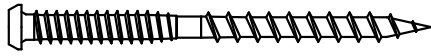

Gauge	Length	Thread	Quantity	Item Code
8	2½"	Multi-Thread	800 Tub	08S250W497



*ICC certified test data available on all highlighted items. Refer to ESR-3558 for details.

Metal to Metal Screws



General purpose screws for fastening metal to metal

Finish:
Clear Zinc



#2 Square Flat Pan Drill

Gauge	Length	Thread	Quantity	Item Code
10	¾"	Fine	1000 Tub	10M075CTMFDS*
10	1"	Fine	1000 Box	10M100CKMFDS*

Finish:
Yellow Zinc



Rex Flat Pan Drill

Gauge	Length	Thread	Quantity	Item Code
10	¾"	Fine	1000 Tub	10M075YTFDFX*

Finish:
Yellow Zinc

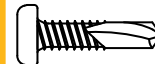

Rex Flat Pan T4 Drill

Gauge	Length	Thread	Quantity	Item Code
10	¾"	22 TPI	8000 Loose	10M075YLF4X*
10	¾"	22 TPI	1000 Box	10M075YKFT4X*

Finish:
Yellow Zinc



Rex Flat Pan T4 Drill

Gauge	Length	Thread	Quantity	Item Code
12	¾"	Fine	1000 Box	12M087YKFF4X*

Finish:
Yellow Zinc



Rex Flat Pan T3 Drill

Gauge	Length	Thread	Quantity	Item Code
12	1"	Fine	1000 Box	12M100YKFF3X*



METAL TO METAL

COLLATED SCREWS

Low Profile Framing Screws



Self tapping metal framing screw

Finish:
Clear Zinc



Gauge	Length	Thread	Quantity	Item Code
8	1/2"	Fine	1000 Tub	08M050CTRFSP*
10	3/4"	Fine	1000 Box	10M075CSK

Self drilling and tapping metal framing screws

Finish:
Clear Zinc



Gauge	Length	Thread	Quantity	Item Code
8	1/2"	Fine	1000 Tub	08M050CTRFDP*
10	3/4"	22 TPI	1000 Box	10M075CDK*

10M075CDK 22 TPI Metal Framing Screw



- Low profile head to reduce drywall flexing
- Higher thread count for better fastener engagement

Specialty Screws



General purpose screws for a range of applications including window installation and crating

Finish:
Clear Zinc

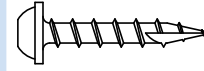

Gauge	Length	Thread	Quantity	Item Code
8	1 1/4"	Coarse	4000 Box	08X125CBACTS

Finish:
Clear Zinc

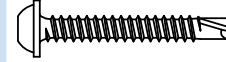

Gauge	Length	Thread	Quantity	Item Code
8	1 1/4"	Double	1000 Box	08X125CKADD5*
8	2"	Double	1000 Box	08X200CKADD5*

Finish:
Clear Zinc



Gauge	Length	Thread	Quantity	Item Code
8	1"	Double	4000 BOX	08M100CBPDSS



LIGHT METAL

Bits for Current Tools

Integrated auto-feed screwdriver — 2 or 25 bits per pack*			
Bits Fit	⊕ ITEM #	◻ ITEM #	⊛ ITEM #
DS222-18V DS225-18V DS242-AC DS245-AC	EA0297 EA0297N*	EA0298 EA0298N*	EA0299 EA0299N*
DS322-18V DS342-AC	EA0400	EA0401	EA0402
Auto-feed attachments and kits — 2 or 25 bits per pack*			
Bits Fit	⊕ ITEM #	◻ ITEM #	⊛ ITEM #
DS230	EA0300	EA0301 EA0301N*	EA0302
DS530 DS532-AC DS534-AC	EA0314	EA0315 EA0315N*	EA0316 EA0316N*
For PAMFast auto-feed screw system — 2 bits per pack			
Bits Fit	⊕ ITEM #	◻ ITEM #	⊛ ITEM #
1"-3" Models	-	EA0396P	EA0397P



*25 count high torque bits for use in metal applications

Bit Tip

Loose screwdriver — 10 bits per pack	
Bits Fit	⊛ ITEM #
SG2510 SG4100	EA0308



DS530 Series Adapters

For attaching screwdrivers to DS530 attachments			
Screwdriver	Fits Tools		Adapter ITEM #
SENCO	SG2510	SG4100	MB0184
DeWalt	DW252 DW253 DW255 DW257	DW266 DW272 DW276	MB0185
	DCF624		MB0183
MAKITA	FS2200 FS2500 FS4200 FS6200	XSF03 XSF04 XSF05	MB0186
	FS2701		MB0187



Bits for Retired Tools

Integrated auto-feed screwdriver — 2 bits per pack			
Bits Fit	⊕ ITEM #	◻ ITEM #	⊛ ITEM #
DS232-AC DS235-AC DS212-18V DS215-18V	EA0297	EA0298	EA0299
DS332-AC DS312-18V	EA0300	EA0301	EA0302
DS425-AC DS440-AC	EA0314	EA0315	EA0316
When attaching to SG2510, SG4100 and Makita with ADP019 & MB0174			
Bits Fit	⊕ ITEM #	◻ ITEM #	⊛ ITEM #
DS220	EA0311	EA0312	EA0313
DS320	EA0314	EA0315	EA0316
When attaching to DeWalt with ADP009			
Bits Fit	⊕ ITEM #	◻ ITEM #	⊛ ITEM #
DS220	EA0317	EA0318	EA0319
DS320	EA0320	EA0321	EA0322

DS220 and DS320 Adapters

For attaching screwdrivers to DS220 and DS320 attachments			
Screwdriver	Fits Tools		Adapter ITEM #
SENCO	SG2510	SG4100	MB0173
DeWalt	DW252 DW253 DW255 DW257	DW266 DW272 DW276	ADP009
MAKITA	FS2200 FS2500 FS4200 FS6200	XSF03 XSF04 XSF05	ADP019
	FS2701		MB0174

SCREW SYSTEM ACCESSORIES

Nosepieces for Current and Retired Tools

For wood applications				For metal framing applications				For general applications			
Fits Tools	Range	ITEM #		Fits Tools	Range	ITEM #		Fits Tools	Range	ITEM #	
DS220 DS230 Series DS222-18V DS225-18V DS242-AC DS245-AC	1"-2"	FB0157		DS220 DS230 Series DS222-18V DS225-18V DS242-AC DS245-AC	½"-1"	FB0155		DS220 DS230 Series DS222-18V DS225-18V DS242-AC DS245-AC	1"-2"	FC1022	
DS320 DS322-18V DS342-AC DS425AC DS440AC DS530 Series DS532-AC DS534-AC	1"-3"	FB0159		DS320 DS322-18V DS342-AC DS425AC DS440AC DS530 Series DS532-AC DS534-AC	½"-1"	FB0187		DS320 DS322-18V DS342-AC DS425AC DS440AC DS530 Series DS532-AC DS534-AC	1"-3"	FC1023	
For drywall applications				DS220 DS230 Series DS222-18V DS225-18V DS242-AC DS245-AC	½"-1"	FB0178					
DS220	1"-2"	FC0878	DS320 DS322-18V DS342-AC DS425AC DS440AC DS530 Series DS532-AC DS534-AC	½"-1"	FB0185						
DS220	1"-2"	FC0878		DS220 DS230 Series DS222-18V DS225-18V DS242-AC DS245-AC	½"-1"	FB0178					
DS320 DS425AC DS440AC	1"-3"	FC0895		DS320 DS322-18V DS342-AC DS425AC DS440AC DS530 Series DS532-AC DS534-AC	½"-1"	FB0185					

Replacement Pads

For use on nosepieces						
Fits Nosepieces	Description	Qty.	ITEM #			
FB0178, FB0185 FC0822, FC0887	Round no-mar pad with adhesive	3	FC0983			
FB0157, FB0159	Square non-skid pad with adhesive	3	FA0334			
FC1022	No-mar pad with clip	1	HA0332			

FINISH & WOODWORKING

THE DIFFERENCE IS IN THE DETAILS

Experience award-winning cordless convenience in all-day, everyday trim tools.

APPLICATIONS

Finish and trim, fine woodworking, cabinet, furniture, decorative trim

KEY FEATURES

- FUSION® cordless air-power technology
- Selectable drive switch allows for contact or sequential trigger actuation
- Nose-mounted LED light
- Adjustable belt hook
- Thumbwheel depth-of-drive
- Quick clear latch feature for quickly clearing jams
- Includes storage bag, battery and charger

SENCO has set the industry standard for pneumatic finish and fine woodworking tools, providing compact, ultra-light, easy-to-use tools designed for precision and longevity.

We offer a broader range of tools than anyone else, covering 15–23 gauge nailers and 16–19 gauge staplers, including the industry benchmark FinishPro®42XP.

APPLICATIONS

Cabinetry, furniture, decorative trim, crown molding, custom woodworking applications and all other finish needs

KEY FEATURES

- Quick clear latch to clear jams fast
- No-mar pads to protect woodwork
- Clear line-of-sight for precision fastening
- Comfort grip
- Adjustable depth-of-drive



F-18XP

2 1/8" 18 GA. CORDLESS PNEUMATIC BRAD NAILER

ITEM #10M0001N



18^{GA}
BRAD

Features

- FUSION® cordless air-power technology
- Sequential or bump fire modes
- Tool-free depth-of-drive
- Includes one Li-ion battery, quick charge battery charger and storage bag

F-15XP

2 1/2" 15 GA. CORDLESS PNEUMATIC FINISH NAILER

ITEM #10L0001N



15^{GA}
DA

Features

- FUSION® cordless air-power technology
- Sequential or bump fire modes
- Tool-free depth-of-drive
- Includes one Li-ion battery, quick charge battery charger and storage bag

F-16XP

2 1/2" 16 GA. CORDLESS PNEUMATIC FINISH NAILER

ITEM #10N0001N



16^{GA}
STRAIGHT

Features

- FUSION® cordless air-power technology
- Sequential or bump fire modes
- Tool-free depth-of-drive
- Includes one Li-ion battery, quick charge battery charger and storage bag

F-LXP

1 1/2" 18 GA. 1/4" CROWN CORDLESS PNEUMATIC FINISH STAPLER

ITEM #10Y0001N



18^{GA}
L

Features

- FUSION® cordless air-power technology
- Sequential or bump fire modes
- Tool-free depth-of-drive
- Includes one Li-ion battery, quick charge battery charger and storage bag

Product Reference Chart

TOOL SPECS	F-18XP	F-16XP	F-15XP	F-LXP
Weight with Battery	6.6 lbs (3.0 kg)	6.7 lbs (3.1 kg)	6.8 lbs (3.1 kg)	6.8 lbs (3.1 kg)
Height	12.5" (318 mm)	12.5" (318 mm)	12.5" (318 mm)	12.5" (318 mm)
Length	10.2" (259 mm)	11.6" (295 mm)	12.6" (320 mm)	10.4" (264 mm)
Width	3.9" (99 mm)	3.9" (99 mm)	5.3" (135 mm)	3.9" (99 mm)
Charge Time	80% in 15 minutes, 100% in 45 minutes			
Warranty	5 yrs	5 yrs	5 yrs	5 yrs
FASTENER SPECS	Fasteners are located on pages 23-25, 27			
Gauge, Gauge/Crown	18	16	15	18/1/4"
Range	5/8"-2 1/8"	3/4"-2 1/2"	1 1/4"-2 1/2"	3/8"-1 1/2"
Capacity	110	110	110	110
Angle/Collation	Straight Glued Strip	Straight Glued Strip	34° Angled Taped Strip	Straight Glued Strip
Series	AY, AX	M0	DA	L
TOOL FEATURES				
Jam Reduction Intelligence	Yes	Yes	Yes	Yes
Depth-of-Drive	Yes, Tool-Free	Yes, Tool-Free	Yes, Tool-Free	Yes, Tool-Free
Quick Clear Jam Clearing	No	No	Yes	No
Trigger Actuation	Sequential or Contact	Sequential or Contact	Sequential or Contact	Sequential or Contact
Nose Mounted LED Light	Yes	Yes	Yes	Yes
Belt Hook	Adjustable and Reversible	Adjustable and Reversible	Adjustable and Reversible	Adjustable and Reversible

TN11G1

1 3/8" HEADLESS PINNER



23^{GA}
PIN

Features

- NEVERLUBE® oil-free design — no oil required
- Magazine automatically adjusts for fastener length
- Ergonomic angled "pistol-grip" handle
- Ultra-narrow nosepiece
- Reversible belt hook
- Last nail lockout

TN11G1P

1 3/8" HEADLESS PINNER



23^{GA}
PIN

Features

- Oil-less design eliminates the need for routine lubrication
- Dry fire lockout reduces tool wear and indicates when to reload
- Ultra-narrow nosepiece allows access to tight corners and other hard to reach areas
- Reversible belt hook mounts to either side of the tool
- No-mar pad prevents damage to the worksurface

TN11L1

2" HEADLESS PINNER



23^{GA}
PIN

Features

- NEVERLUBE® oil-free design — no oil required
- Magazine automatically adjusts for fastener length
- Ergonomic angled "pistol-grip" handle
- Ultra-narrow nosepiece
- Reversible belt hook
- Last nail lockout

Product Reference Chart

TOOL SPECS	TN11G1	TN11L1	TN11G1P1
Trigger	Sequential	Sequential	Sequential
Operating Pressure	70-100 psi (4.8-6.9 bar)	70-110 psi (4.8-7.6 bar)	70-100 psi (4.8-6.9 bar)
Air Consumption (60 CPM)	1.1 scfm	1.1 scfm	1.1 scfm
Air Inlet	1/4" NPT	1/4" NPT	1/4" NPT
Weight	2.41 lbs (1.09 kg)	2.86 lbs (1.3 kg)	2.3 lbs (1.0 kg)
Height	7.8" (198 mm)	9.2" (233 mm)	7.5" (191 mm)
Length	8.57" (218 mm)	8.69" (220 mm)	7.5" (191 mm)
Width	2.6" (66 mm)	2.6" (66 mm)	1.9" (48 mm)
Main Body Material	Aluminum	Aluminum	Aluminum
Warranty	5 yrs	5 yrs	5 yrs
FASTENER SPECS	Fasteners are located on page 23		
Gauge	23	23	23
Range	1/2"-1 3/8"	1/2"-2"	1/2"-1 3/8"
Capacity	100	100	100
Angle/Collation	Straight Glued Strip	Straight Glued Strip	Straight Glued Strip
Series	A1, CZ	A1, CZ	CZ
TOOL FEATURES			
Depth-of-Drive	No	No	No
Belt Hook	Yes	Yes	Yes
NEVERLUBE®/Oil-Less	NEVERLUBE®	NEVERLUBE®	Oil-Less
Exhaust	Rear	Rear	Rear

TN21L1

2" PINNER



21^{GA}
PIN

Features

- NEVERLUBE® oil-free design — no oil required
- Magazine automatically adjusts for fastener length
- Ergonomic angled "pistol-grip" handle
- Ultra-narrow nosepiece
- Reversible belt hook
- Last nail lockout

BN31M1P

2½" BRAD NAILER



18^{GA}
BRAD

Features

- Oil-less design eliminates the need for routine lubrication
- Dry fire lockout reduces tool wear and indicates when to reload
- Selectable trigger to switch between contact or sequential firing modes
- Quick clear latch to easily clear jams or misfeeds
- Tool-free depth adjustment for consistent flush or countersunk drives

LS1XP

1" HEADLESS BRAD NAILER

ITEM #8N0001N



18^{GA}
BRAD

Features

- NEVERLUBE® oil-free design — no oil required
- Ergonomic handle for all-day comfort
- Narrow nose for tight corners

FinishPro®18Mg

2½" BRAD NAILER

ITEM #1U0021N



18^{GA}
BRAD

Features

- Oil-less design eliminates the need for routine lubrication
- Metal cylinder for increased durability
- Quick clear latch virtually eliminates downtime caused by fastener jams
- Narrow nose for tight corners
- Includes case, swivel air plug and wrench

Product Reference Chart

TOOL SPECS	TN21L1	LS1XP	BN31M1P	FinishPro®18Mg
Trigger	Sequential	Sequential	Selectable	Selectable
Operating Pressure	70-110 psi (4.8-7.6 bar)	70-120 psi (4.8-8.3 bar)	70-120 psi (4.8-8.3 bar)	70-120 psi (4.8-8.3 bar)
Air Consumption (60 CPM)	1.1 scfm	1.92 scfm	2.4 scfm	2.4 scfm
Air Inlet	¼" NPT	¼" NPT	¼" NPT	¼" NPT
Weight	3.16 lbs (1.43 kg)	2.9 lbs (1.3 kg)	3.0 lbs (1.4 kg)	2.48 lbs (1.12 kg)
Height	9.2" (233 mm)	8.25" (210 mm)	9.75" (248 mm)	9.75" (248 mm)
Length	8.76" (222 mm)	9" (229 mm)	10.5" (267 mm)	10.5" (267 mm)
Width	2.6" (66 mm)	2" (51 mm)	2.5" (63.5 mm)	2.5" (63.5 mm)
Main Body Material	Aluminum	Aluminum	Aluminum	Magnesium
Warranty	5 yrs	5 yrs	5 yrs	5 yrs
FASTENER SPECS	Fasteners are located on pages 23-24			
Gauge	21	18	18	18
Range	⅝"-2"	½"-1"	⅝"-2⅛"	⅝"-2⅛"
Capacity	200	100	110	110
Angle/Collation	Straight Glued Strip	Straight Glued Strip	Straight Glued Strip	Straight Glued Strip
Series	ZX	AZ	AX	AX
TOOL FEATURES				
Depth-of-Drive	No	No	Yes, Tool-Free	Yes, Tool-Free
Belt Hook	Yes	Fixed	Yes	Yes
NEVERLUBE®/Oil-Less	NEVERLUBE®	NEVERLUBE®	Oil-Less	Oil-Less
Exhaust	Rear	Fixed	Rear Adjustable	Rear Adjustable

FinishPro®18BMg

2½" BRAD NAILER

ITEM #9B0001N



18^{GA}
BRAD

Features

- Oil-less design eliminates the need for routine lubrication
- Ultra-lightweight for ease of use and maneuverability
- Nose mounted LED light illuminates dark work spaces
- Includes case, swivel air plug and wrench

FinishPro®25XP

2½" BRAD NAILER

ITEM #760102N



18^{GA}
BRAD

Features

- NEVERLUBE® oil-free design — no oil required
- Drives both slight and medium headed brads
- Powerful — ensures complete drives into hard substrates
- Includes case

SLP20XP

1½" BRAD NAILER

ITEM #430101N



18^{GA}
BRAD

Features

- NEVERLUBE® oil-free design — no oil required
- Drives both slight and medium headed brads
- Muffler ensures quieter operation
- Includes case

TN41P1P

2½" FINISH NAILER



16^{GA}
STRAIGHT

Features

- Oil-less design eliminates the need for routine lubrication
- Dry fire lockout reduces tool wear and indicates when to reload
- Selectable trigger to switch between contact or sequential firing modes
- Quick clear latch to easily clear jams or misfeeds
- Tool-free depth adjustment for consistent flush or countersunk drives

Product Reference Chart

TOOL SPECS	FinishPro®18BMg	SLP20XP	FinishPro®25XP	TN41P1P
Trigger	Selectable	Sequential	Sequential	Selectable
Operating Pressure	70-120 psi (4.8-8.3 bar)	70-120 psi (4.8-8.3 bar)	70-120 psi (4.8-8.3 bar)	70-120 psi (4.8-8.3 bar)
Air Consumption (60 CPM)	1.6 scfm	1.92 scfm	1.92 scfm	2.22 scfm
Air Inlet	¼" NPT	¼" NPT	¼" NPT	¼" NPT
Weight	2.8 lbs (1.26 kg)	2.3 lbs (1 kg)	2.7 lbs (1.2 kg)	4.6 lbs (2.1 kg)
Height	9.8" (248 mm)	8.25" (210 mm)	9.9" (251 mm)	11.4" (290 mm)
Length	10" (255 mm)	9.5" (241 mm)	9.8" (249 mm)	12" (305 mm)
Width	2.5" (63.5 mm)	2" (50.8 mm)	2.2" (56 mm)	4" (102 mm)
Main Body Material	Magnesium	Aluminum	Aluminum	Aluminum
Warranty	5 yrs	5 yrs	5 yrs	5 yrs
FASTENER SPECS	Fasteners are located on pages 23-24			
Gauge	18	18	18	16
Range	⅝" - 2½"	⅝" - 1½"	⅝" - 2½"	1¼" - 2½"
Capacity	100	110	110	110
Angle/Collation	Straight Glued Strip	Straight Glued Strip	Straight Glued Strip	Straight Glued Strip
Series	AX	AX, AY	AX, AY	A4, MO
TOOL FEATURES				
Depth-of-Drive	Yes, Tool-Free	No	Yes, Tool-Free	Yes, Tool-Free
Belt Hook	Yes	No	Yes	Yes
NEVERLUBE®/Oil-Less	Oil-Less	NEVERLUBE®	NEVERLUBE®	Oil-Less
Exhaust	Rear Adjustable	Fixed	Adjustable	Adjustable

FinishPro® 30XP

2" ANGLED FINISH NAILER

ITEM #9P0002N



15^{GA}
DA

Features

- NEVERLUBE® oil-free design — no oil required
- Quick clear latch virtually eliminates downtime caused by fastener jams
- Adjustable depth of drive
- Includes case and belt hook

FinishPro® 42XP

2½" ANGLED FINISH NAILER

ITEM #4G0001N



15^{GA}
DA

Features

- NEVERLUBE® oil-free design — no oil required
- Quick clear latch virtually eliminates downtime caused by fastener jams
- High-strength driver with threaded connection
- Metal cylinder for increased durability
- Includes case, belt hook and contact trigger kit

TN51P1P

2½" ANGLED FINISH NAILER



15^{GA}
DA

Features

- Oil-less design eliminates the need for routine lubrication
- Dry fire lockout reduces tool wear and indicates when to reload
- Selectable trigger to switch between contact or sequential firing modes
- Quick clear latch to easily clear jams or misfeeds
- Tool-free depth adjustment for consistent flush or countersunk drives

Product Reference Chart

TOOL SPECS	FinishPro®30XP	TN51P1P	FinishPro®42XP
Trigger	Sequential	Selectable	Sequential
Operating Pressure	70–120 psi (4.8–8.3 bar)	70–120 psi (4.8–8.3 bar)	70–120 psi (4.8–8.3 bar)
Air Consumption (60 CPM)	2.16 scfm	3.2 scfm	3.87 scfm
Air Inlet	¼" NPT	¼" NPT	¼" NPT
Weight	3.8 lbs (1.73 kg)	4.5 lbs (2.0 kg)	4.7 lbs (2.1 kg)
Height	9.63" (244.6 mm)	12.25" (311 mm)	11.25" (286 mm)
Length	12" (305 mm)	13" (330 mm)	13" (330 mm)
Width	3.25" (82.5 mm)	3.5" (89 mm)	3.5" (89 mm)
Main Body Material	Magnesium	Aluminum	Magnesium
Warranty	5 yrs	5 yrs	5 yrs
FASTENER SPECS	Fasteners are located on page 25		
Gauge	15	15	15
Range	1"–2"	1¼"–2½"	1¼"–2½"
Capacity	104	110	104
Angle/Collation	34° Angled Tape Strip	34° Angled Tape Strip	34° Angled Tape Strip
Series	DA	DA	DA
TOOL FEATURES			
Depth-of-Drive	Yes, Tool-Free	Yes, Tool-Free	Yes, Tool-Free
Belt Hook	Yes	Yes	Yes
NEVERLUBE®/Oil-Less	NEVERLUBE®	Oil-Less	NEVERLUBE®
Exhaust	Fixed	Adjustable	Adjustable

SLS20XP

3/16", 1/4", 3/8" CROWNS, 1 1/2" FINISH STAPLER

SEE ITEM # CHART



Features

- NEVERLUBE® design — no oil required
- Ultra-lightweight for ease of use and maneuverability
- Metal cylinder for increased durability
- Muffler ensures quieter operation

SLS25XP

1/4", 3/8" CROWNS, 1 1/2" FINISH STAPLER

SEE ITEM # CHART



Features

- NEVERLUBE® design — no oil required
- Ultra-lightweight for ease of use and maneuverability
- Metal cylinder for increased durability
- Muffler ensures quieter operation

SKSXP

1/4", 3/8", 7/16" CROWNS, 1 1/2" FINISH/HEAVY WIRE STAPLER

SEE ITEM # CHART



Features

- NEVERLUBE® design — no oil required
- Quick clear latch virtually eliminates downtime caused by fastener jams
- Long 1" lip to get into tight spots

SLS20XP, SLS25XP and SKSXP Item Code Chart

Model	Crown	Item Code
SLS20XP-K	1/4"	490101N
SLS20XP-L	1/4"	490103N
SLS20XP-L W/CASE	1/4"	490105N
SLS20XP-L SENCOMATIC	1/4"	490015N
SLS20XP-M	3/8"	490107N
SLS20XP-R	3/16"	490111N
SLS25XP-L	1/4"	820103N
SLS25XP-M	3/8"	820107N
SKSXP-L	1/4"	300120N
SKSXP-M	3/8"	300152N
SKSXP-N	7/16"	300184N

Product Reference Chart

TOOL SPECS	SLS20XP	SLS25XP	SKSXP
Trigger	Sequential	Contact	Sequential
Operating Pressure	70-120 psi (4.8-8.3 bar)	70-120 psi (4.8-8.3 bar)	70-120 psi (4.8-8.3 bar)
Air Consumption (60 CPM)	1.92 scfm	1.92 scfm	2.16 scfm
Air Inlet	1/4" NPT	1/4" NPT	1/4" NPT
Weight	2.5 lbs (1.13 kg)	2.67 lbs (1.21 kg)	4.2 lbs (1.9 kg)
Height	8.5" (216 mm)	9" (229 mm)	9.25" (238 mm)
Length	12" (305 mm)	12" (305 mm)	12.38" (314 mm)
Width	2" (50.8 mm)	2" (50.8 mm)	3" (76 mm)
Main Body Material	Aluminum	Aluminum	Aluminum
Warranty	5 yrs	5 yrs	5 yrs
FASTENER SPECS	Fasteners are located on pages 26-28		
Gauge	19, 18	18	18, 16
Crown	3/16", 1/4", 3/8"	1/4", 3/8"	1/4", 3/8", 7/16"
Range	3/8"-1 1/2"	3/8"-1 1/2"	3/4"-1 1/2"
Capacity	168	168	145
Angle/Collation	Straight Glued Strip	Straight Glued Strip	Straight Glued Strip
Series	K, L, M, R	L, M	L, M, N
TOOL FEATURES			
Depth-of-Drive	Yes	Yes	No
Belt Hook	No	No	No
NEVERLUBE®/Oil-Less	NEVERLUBE®	NEVERLUBE®	NEVERLUBE®

SLS150Mg

¼" CROWN, 1⅞" FINISH STAPLER

ITEM #8C0001N



18^{GA}
L

Features

- Oil-less design eliminates the need for routine lubrication
- Ultra-lightweight for ease of use and maneuverability
- Nose-mounted LED light — illuminates work surface
- Durable composite magazine
- Reload indicator on magazine
- Includes case and wrench

LS61H1P

¼" CROWN, 1½" FINISH STAPLER



18^{GA}
L

Features

- Oil-less design eliminates the need for routine lubrication
- Selectable trigger to switch between contact or sequential firing modes
- Tool-free depth adjustment for consistent flush or countersunk drives
- 360° adjustable exhaust directs air away from the operator or work surface
- Rotatable belt hook for quick right/left hand access

Product Reference Chart

TOOL SPECS	SLS150Mg	LS61H1P
Trigger	Selectable	Selectable
Operating Pressure	70-120 psi (4.8-8.3 bar)	70-120 psi (4.8-8.3 bar)
Air Consumption (60 CPM)	2.4 scfm	2.4 scfm
Air Inlet	¼" NPT	¼" NPT
Weight	2.6 lbs (1.8 kg)	3.1 lbs (1.4 kg)
Height	9.5" (241 mm)	9.5" (241 mm)
Length	10.25" (260 mm)	10.25" (260 mm)
Width	2.5" (63.5 mm)	2.5" (63.5 mm)
Main Body Material	Magnesium	Aluminum
Warranty	5 yrs	5 yrs
FASTENER SPECS	Fasteners are located on page 27	
Gauge	18	18
Crown	¼"	¼"
Range	½"-1⅞"	⅜"-1½"
Capacity	110	110
Angle/Collation	Straight Glued & Taped Strip	Straight Glued & Taped Strip
Series	L	L
TOOL FEATURES		
Depth-of-Drive	Yes, Tool-Free	Yes, Tool-Free
Belt Hook	Yes	Yes
NEVERLUBE®/Oil-Less	Oil-Less	Oil-Less

SC1XP Senclamp®

7/16" CROWN, 9/16" SENCLAMP® FASTENER

ITEM #220101N



Features

- Senclamp® fasteners pull the joint together during driving for a tight, permanent fit
- Eliminates milling, doweling, clamping, screwing and other time-consuming, cost-adding operations
- The Senclamp high-carbon steel fastener derives added strength from its special webbed design

SC2 Sencor®

1" CROWN, 1/2" CORRUGATED STAPLER

ITEM #470001N



Features

- Powerful — ensures complete drives into hard substrates
- Eliminates gluing, milling, doweling, screwing and clamping
- Added strength for larger butt joints

Product Reference Chart

TOOL SPECS	SC1XP Senclamp®	SC2 Sencor®
Trigger	Sequential	Sequential
Operating Pressure	80-110 psi (5.5-7.5 bar)	80-110 psi (5.5-7.5 bar)
Air Consumption (60 CPM)	3.8 scfm	3.7 scfm
Air Inlet	3/8" NPT	3/8" NPT
Weight	6.3 lbs (2.8 kg)	6.9 lbs (3.1 kg)
Height	9.8" (249 mm)	9.44" (240 mm)
Length	12.7" (322 mm)	12.5" (318 mm)
Width	2.5" (63.5 mm)	2" (50.8 mm)
Main Body Material	Aluminum	Aluminum
Warranty	5 yrs	5 yrs
FASTENER SPECS	Fasteners are located on page 29	
Gauge	25	25
Crown	7/16"	1"
Range	5/16" - 9/16"	1/4" - 1/2"
Capacity	120	80
Angle/Collation	Straight Glued & Taped Strip	Straight Glued Strip
Series	Y	X
TOOL FEATURES		
Depth-of-Drive	No	No
Belt Hook	No	No
NEVERLUBE®/Oil-Less	No	No

FINISH & WOODWORKING FASTENERS

23^{GA}
PIN

Headless Straight Strip Pins

Pins fasten the smallest of trim securely leaving a nearly invisible hole

Length	Point	Head	Finish	Coating	Collation	Box Count	Item Code
1/2"	Chisel	Headless	Galv	Plain	Straight Glued Strip	15.5M	CZ08EAAN
5/8"	Chisel	Headless	Galv	Plain	Straight Glued Strip	10M	CZ10EAA
3/4"	Chisel	Headless	Galv	Plain	Straight Glued Strip	15.5M	CZ10EAAN
3/4"	Chisel	Headless	Galv	Plain	Straight Glued Strip	10M	CZ11EAA
3/4"	Chisel	Headless	Galv	Plain	Straight Glued Strip	15.5M	CZ11EAAN
1"	Chisel	Headless	Galv	Plain	Straight Glued Strip	10M	CZ13EAA
1 1/4"	Chisel	Headless	Galv	Plain	Straight Glued Strip	10M	CZ15EAA
1 3/8"	Chisel	Headless	Galv	Plain	Straight Glued Strip	10M	CZ16EAA
1 1/2"	Chisel	Headless	Galv	Plain	Straight Glued Strip	10M	CZ17EAA
2"	Chisel	Headless	Galv	Plain	Straight Glued Strip	10M	CZ21EAA
1/2"	Chisel	Headless	Galv	Plain	Straight Glued Strip	2.6M	CZ08EAAR
5/8"	Chisel	Headless	Galv	Plain	Straight Glued Strip	2.6M	CZ10EAAR
3/4"	Chisel	Headless	Galv	Plain	Straight Glued Strip	2.6M	CZ11EAAR
1"	Chisel	Headless	Galv	Plain	Straight Glued Strip	2.6M	CZ13EAAR
1 1/4"	Chisel	Headless	Galv	Plain	Straight Glued Strip	2.6M	CZ15EAAR
1 3/8"	Chisel	Headless	Galv	Plain	Straight Glued Strip	2.6M	CZ16EAAR
1 1/2"	Chisel	Headless	Galv	Plain	Straight Glued Strip	2.6M	CZ17EAAR
2"	Chisel	Headless	Galv	Plain	Straight Glued Strip	2.6M	CZ21EAAR
1/2"-1"	Chisel	Headless	Galv	Plain	Straight Glued Strip	2.8M	A109809R*

*Variety Pack

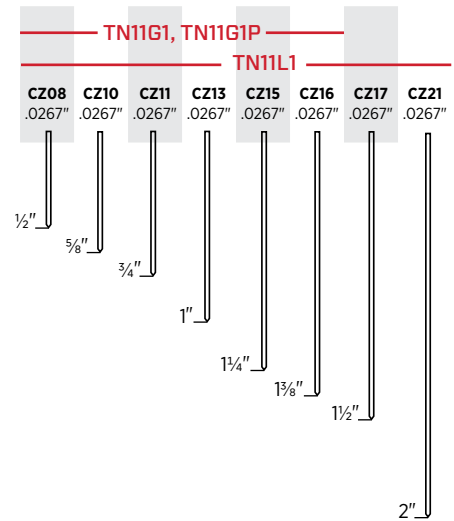

21^{GA}
PIN

Medium Straight Strip Pins

21 gauge pins offer significantly more holding power than 23 gauge pins while leaving a much smaller indent than an 18 gauge brad

Length	Point	Head	Finish	Coating	Collation	Box Count	Item Code
5/8"	Chisel	Medium	Galv	Plain	Straight Glued Strip	5M	ZX10EAA
1"	Chisel	Medium	Galv	Plain	Straight Glued Strip	5M	ZX13EAA
1 3/8"	Chisel	Medium	Galv	Plain	Straight Glued Strip	5M	ZX16EAA
1 5/8"	Chisel	Medium	Galv	Plain	Straight Glued Strip	5M	ZX18EAA
2"	Chisel	Medium	Galv	Plain	Straight Glued Strip	5M	ZX21EAA
5/8"	Chisel	Medium	Galv	Plain	Straight Glued Strip	2M	ZX10EAAR
1"	Chisel	Medium	Galv	Plain	Straight Glued Strip	2M	ZX13EAAR
1 3/8"	Chisel	Medium	Galv	Plain	Straight Glued Strip	2M	ZX16EAAR
1 5/8"	Chisel	Medium	Galv	Plain	Straight Glued Strip	2M	ZX18EAAR
2"	Chisel	Medium	Galv	Plain	Straight Glued Strip	2M	ZX21EAAR

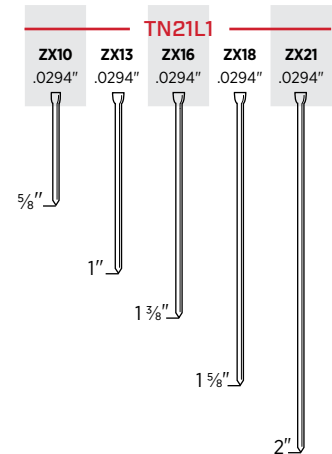

18^{GA}
BRAD

Straight Strip Brad Nails

Cabinets, decorative trim, picture frames and molding

Length	Point	Head	Finish	Coating	Collation	Box Count	Item Code
5/8"	Chisel	Medium	Galv	Plain	Straight Glued Strip	5M	AX10EAA
3/4"	Chisel	Medium	Galv	Plain	Straight Glued Strip	5M	AX11EAA
1"	Chisel	Medium	Galv	Plain	Straight Glued Strip	5M	AX13EAA
1 1/4"	Chisel	Medium	Galv	Plain	Straight Glued Strip	5M	AX15EAA
1 1/2"	Chisel	Medium	Galv	Plain	Straight Glued Strip	5M	AX17EAA
1 5/8"	Chisel	Medium	Galv	Plain	Straight Glued Strip	5M	AX18EAA
1 3/4"	Chisel	Medium	Galv	Plain	Straight Glued Strip	5M	AX19EAA
2"	Chisel	Medium	Galv	Plain	Straight Glued Strip	5M	AX21EAAN
2 1/8"	Chisel	Medium	Galv	Plain	Straight Glued Strip	5M	AX22EAAN
3/4"	Chisel	Medium	Galv	Plain	Straight Glued Strip	1M	AX11EAAR
1"	Chisel	Medium	Galv	Plain	Straight Glued Strip	1M	AX13EAAR
1 1/4"	Chisel	Medium	Galv	Plain	Straight Glued Strip	1M	AX15EAAR
1 1/2"	Chisel	Medium	Galv	Plain	Straight Glued Strip	1M	AX17EAAR
2"	Chisel	Medium	Galv	Plain	Straight Glued Strip	1M	AX21EAAR
2 1/8"	Chisel	Medium	Galv	Plain	Straight Glued Strip	1M	AX22EAAR
5/8"-1 1/4"	Chisel	Medium	Galv	Plain	Straight Glued Strip	1.2M	A209809R*
1-2"	Chisel	Medium	Galv	Plain	Straight Glued Strip	1.2M	A209909R*

*Variety Pack

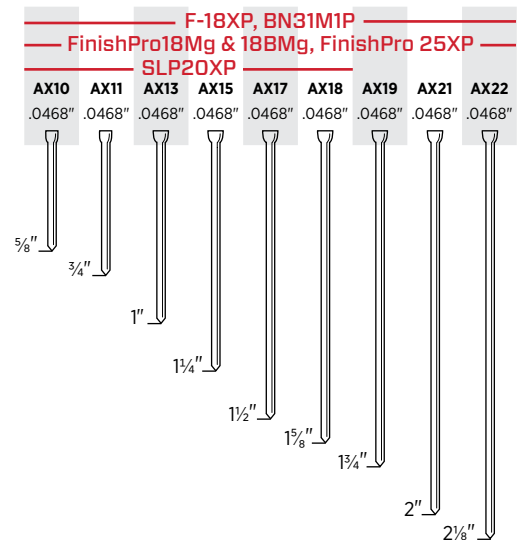

18^{GA}
BRAD

Headless and Slight Head Brad Nails

Cabinets, decorative trim, picture frames and molding

Length	Point	Head	Finish	Coating	Collation	Box Count	Item Code
½"	Chisel	Headless	Galv	Plain	Straight Glued Strip	5M	AZ08EAA
¾"	Chisel	Headless	Galv	Plain	Straight Glued Strip	5M	AZ11EAA
1"	Chisel	Headless	Galv	Plain	Straight Glued Strip	5M	AZ13EAA
⅝"	Chisel	Slight	Galv	Plain	Straight Glued Strip	5M	AY10EAA
¾"	Chisel	Slight	Galv	Plain	Straight Glued Strip	5M	AY11EAA
1"	Chisel	Slight	Galv	Plain	Straight Glued Strip	5M	AY13EAA

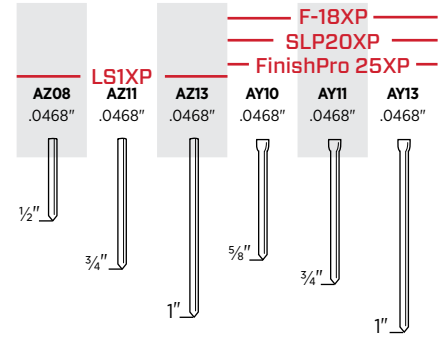

16^{GA}
STRAIGHT

Straight Strip Finish Nails

Furniture and cabinets, molding and trim, baseboard, chair rails, window casings and upholstery trim panels

Length	Point	Head	Finish	Coating	Collation	Box Count	Item Code
¾"	Chisel	T-head	Galv	Plain	Straight Glued Strip	2M	M001000
1"	Chisel	T-head	Galv	Plain	Straight Glued Strip	2M (PT)	M001001
1¼"	Chisel	T-head	Galv	Plain	Straight Glued Strip	2M (PT)	M001002
1½"	Chisel	T-head	Galv	Plain	Straight Glued Strip	2M (PT)	M001003
1¾"	Chisel	T-head	Galv	Plain	Straight Glued Strip	2M (PT)	M001004
2"	Chisel	T-head	Galv	Plain	Straight Glued Strip	2M (PT)	M001005
2½"	Chisel	T-head	Galv	Plain	Straight Glued Strip	2M (PT)	M001007
¾"	Chisel	T-head	Galv	Plain	Straight Glued Strip	1M	M001000R
1"	Chisel	T-head	Galv	Plain	Straight Glued Strip	1M	M001001R
1¼"	Chisel	T-head	Galv	Plain	Straight Glued Strip	1M	M001002R
1½"	Chisel	T-head	Galv	Plain	Straight Glued Strip	1M	M001003R
1¾"	Chisel	T-head	Galv	Plain	Straight Glued Strip	1M	M001004R
2"	Chisel	T-head	Galv	Plain	Straight Glued Strip	1M	M001005R
2¼"	Chisel	T-head	Galv	Plain	Straight Glued Strip	1M	M001006R
2½"	Chisel	T-head	Galv	Plain	Straight Glued Strip	1M	M001007R

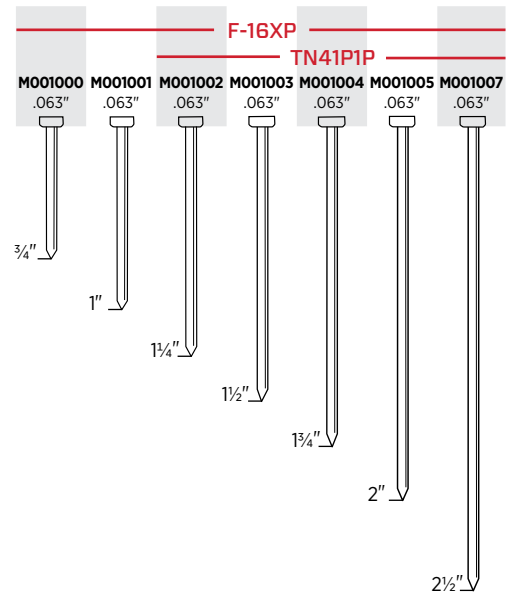

PT-Plastic Tub

15^{GA}
DA

Angled Strip Finish Nails

Furniture and cabinets, molding and trim, baseboard, chair rails, doors and window casing

Length	Point	Head	Finish	Coating	Collation	Box Count	Item Code
1"	Chisel	Brad	Bright	Sencote	34° Angled Tape Strip	4M	DA13EPBN
1¼"	Chisel	Brad	Bright	Sencote	34° Angled Tape Strip	4M	DA15EPBN
1½"	Chisel	Brad	Bright	Sencote	34° Angled Tape Strip	4M	DA17EPBN
1¾"	Chisel	Brad	Bright	Sencote	34° Angled Tape Strip	4M	DA19EPBN
2"	Chisel	Brad	Bright	Sencote	34° Angled Tape Strip	4M	DA21EPBN
2¼"	Chisel	Brad	Bright	Sencote	34° Angled Tape Strip	4M	DA23EPBN
2½"	Chisel	Brad	Bright	Sencote	34° Angled Tape Strip	3M	DA25EPB
1¼"	Chisel	Brad	Galv	Sencote	34° Angled Tape Strip	4M	DA15EABN
1½"	Chisel	Brad	Galv	Sencote	34° Angled Tape Strip	4M	DA17EABN
1¾"	Chisel	Brad	Galv	Sencote	34° Angled Tape Strip	4M	DA19EABN
2"	Chisel	Brad	Galv	Sencote	34° Angled Tape Strip	4M	DA21EABN
2½"	Chisel	Brad	Galv	Sencote	34° Angled Tape Strip	3M	DA25EAB
1¼"	Diamond	Brad	Hardened*	Plain	34° Angled Tape Strip	4M	DA15AIA
1½"	Diamond	Brad	Hardened*	Plain	34° Angled Tape Strip	4M	DA17AIA
1¾"	Diamond	Brad	Hardened*	Plain	34° Angled Tape Strip	4M	DA19AIA
1"	Chisel	Brad	Bright	Plain	34° Angled Tape Strip	1M	DA13EPBR
1¼"	Chisel	Brad	Bright	Plain	34° Angled Tape Strip	1M	DA15EPBR
1½"	Chisel	Brad	Bright	Plain	34° Angled Tape Strip	1M	DA17EPBR
1¾"	Chisel	Brad	Bright	Plain	34° Angled Tape Strip	1M	DA19EPBR
2"	Chisel	Brad	Bright	Plain	34° Angled Tape Strip	1M	DA21EPBR
2½"	Chisel	Brad	Bright	Plain	34° Angled Tape Strip	1M	DA25EPBR
1"	Chisel	Brad	Galv	Plain	34° Angled Tape Strip	1M	DA13EABR
1¼"	Chisel	Brad	Galv	Plain	34° Angled Tape Strip	1M	DA15EABR
1½"	Chisel	Brad	Galv	Plain	34° Angled Tape Strip	1M	DA17EABR
1¾"	Chisel	Brad	Galv	Plain	34° Angled Tape Strip	1M	DA19EABR
2"	Chisel	Brad	Galv	Plain	34° Angled Tape Strip	1M	DA21EABR
2½"	Chisel	Brad	Galv	Plain	34° Angled Tape Strip	1M	DA25EABR
2"	Chisel	Brad	Stainless 304	Plain	34° Angled Tape Strip	1M	DA21EGBR
2½"	Chisel	Brad	Stainless 304	Plain	34° Angled Tape Strip	1M	DA25EGBR

*Hardened regular galvanized heat treated 15 Gauge for steel stud and trim applications

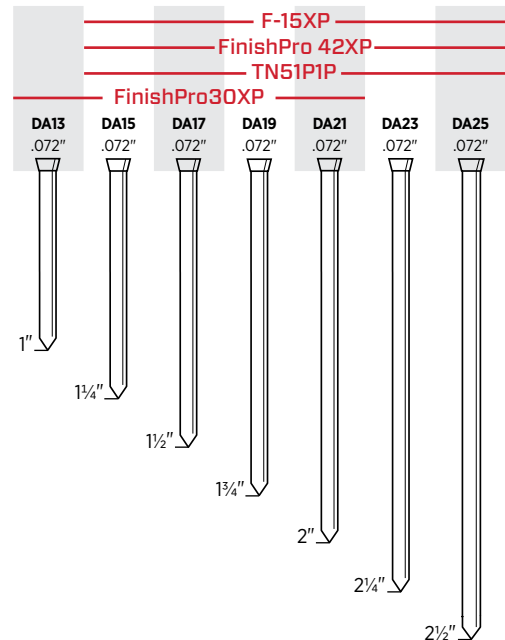

The Best Finish Nails in the Business.

SENCO® has the finish nails to meet all your finish and trim needs. In addition to offering a wide variety of fastener ranges and gauges, we provide a full line of tools to drive them.

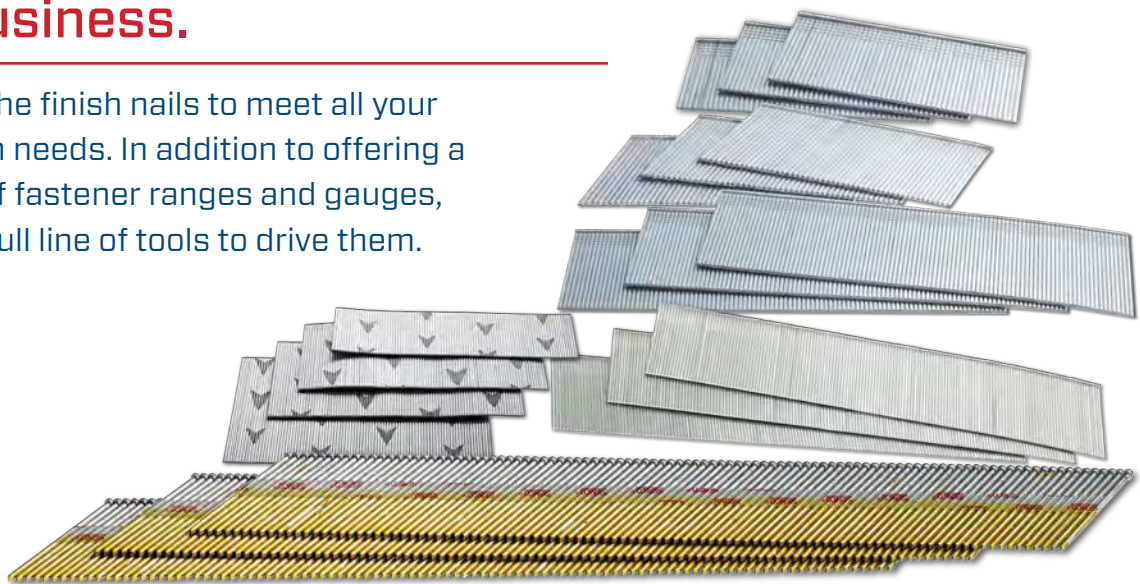

19^{GA}
K

1/4" Crown Finish Staples

Cabinets, drawers, soffits, lattice, casebacks

Length	Point	Finish	Coating	Collation	Box Count	Item Code
3/4"	Chisel	Galv	Sencote	Glued	10M	K11BAB
7/8"	Chisel	Galv	Sencote	Glued	5M	K12BAB
1"	Chisel	Galv	Sencote	Glued	5M	K13BABN

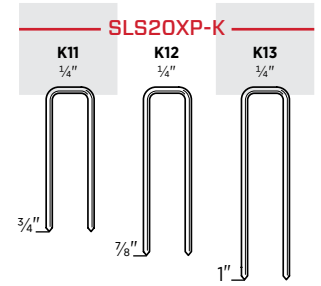

19^{GA}
R

3/16" Crown Finish Staples

Cabinets, drawers, lattice, laminated hardwood flooring

Length	Point	Finish	Coating	Collation	Box Count	Item Code
1/2"	Blunt	Galv	Sencote	Glued	10M	R08BAB
5/8"	Blunt	Galv	Sencote	Glued	5M	R10BAB
3/4"	Blunt	Galv	Sencote	Glued	5M	R11BAB
1"	Blunt	Galv	Sencote	Glued	5M	R13BAB

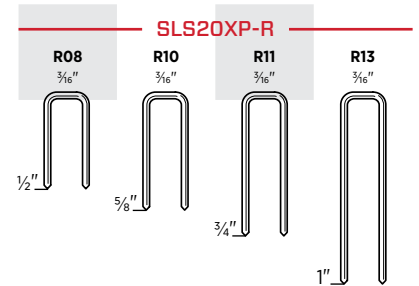

FINISH & WOODWORKING FASTENERS

18^{BA}
L

1/4" Crown Finish Staples

Cabinets, casebacks, drawers, upholstery, soffits, underlayment, lattice and insulation sheathing

Length	Point	Finish	Coating	Collation	Box Count	Item Code
3/4"	Chisel	Bright	Sencote	Glued	5M	L11BRB
1"	Chisel	Bright	Sencote	Glued	5M	L13BRBN
1"	Chisel	Bright	Sencote	Glued	40M	L13BRBP
1 1/8"	Chisel	Bright	Sencote	Glued	5M	L14BRB
1 1/4"	Chisel	Bright	Sencote	Glued	5M	L15BRB
3/8"	Chisel	Galv	Sencote	Glued	10M	L06BAB
7/16"	Chisel	Galv	Sencote	Glued	24M	L07BABP
1/2"	Chisel	Galv	Sencote	Glued	10M	L08BAB
5/8"	Chisel	Galv	Sencote	Glued	5M	L10BABN
5/8"	Cross Cut	Galv	Sencote	Glued	5M	L10HABN
3/4"	Chisel	Galv	Sencote	Glued	5M	L11BAB
3/4"	Cross Cut	Galv ¹	Sencote	Glued	5M	L11HBB
3/4"	Cross Cut	Galv	Sencote	Glued	5M	L11HAB
7/8"	Chisel	Galv	Sencote	Glued	5M	L12BAB
7/8"	Chisel	Galv	Sencote	Glued	5M	L12BQB
1"	Chisel	Galv	Sencote	Glued	5M	L13BABN
1"	Cross Cut	Galv	Sencote	Glued	5M	L13HABN
1 1/8"	Chisel	Galv	Sencote	Glued	5M	L14BAB
1 1/4"	Chisel	Galv	Sencote	Glued	5M	L15BAB
1 1/2"	Chisel	Galv	Sencote	Glued	5M	L17BAB
5/8"	Chisel	Stainless 304 ²	Plain	Glued	5M	L10BHA
3/4"	Chisel	Stainless 304	Plain	Glued	5M	L11BGA
1 1/8"	Chisel	Stainless 304	Plain	Glued	5M	L14BGA
5/8"	Chisel	Galv	Plain	Glued	1M	L10BABR
3/4"	Chisel	Galv	Plain	Glued	1M	L11BABR
1"	Chisel	Galv	Plain	Glued	1M	L13BABR
1 1/4"	Chisel	Galv	Plain	Glued	1M	L15BABR
1 1/2"	Chisel	Galv	Plain	Glued	1M	L17BABR
1/2"-1 1/2"	Chisel	Galv	Plain	Glued	1M	A809909R*
3/4"	Chisel	Stainless 304	Plain	Glued	1M	L11BGBR
1 1/8"	Chisel	Stainless 304	Plain	Glued	1M	L14BGBR

¹ Galvanized High Tensile, ² Stainless 304 High Tensile, * Variety Pack

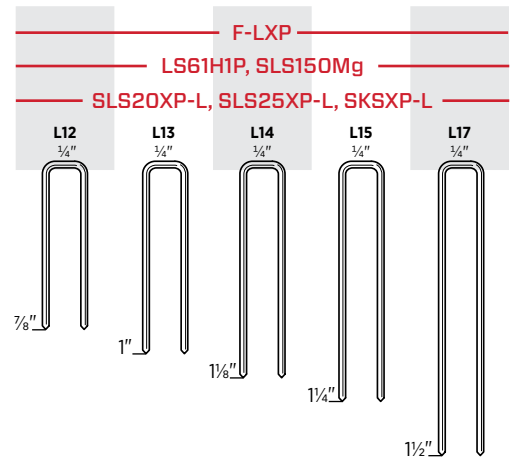
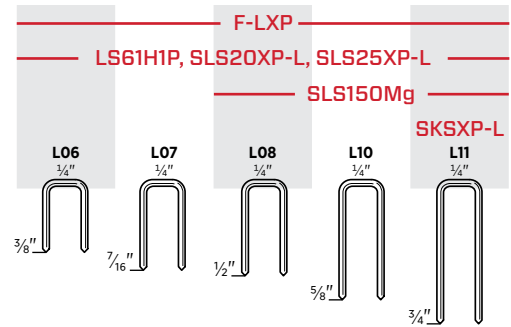

FINISH & WOODWORKING FASTENERS

18
M

3/8" Crown Finish Staples

Cabinets, casebacks, drawers, upholstery, soffits, underlayment, lattice and sheathing						
Length	Point	Finish	Coating	Collation	Box Count	Item Code
5/8"	Chisel	Bright	Sencote	Glued	5M	M10BRBN
3/4"	Chisel	Bright	Sencote	Glued	5M	M11BRBN
1"	Chisel	Bright	Sencote	Glued	5M	M13BRB
3/8"	Chisel	Galv	Sencote	Glued	10M	M06BABN
1/2"	Chisel	Galv	Sencote	Glued	10M	M08BAB
5/8"	Chisel	Galv	Sencote	Glued	5M	M10BABN
3/4"	Chisel	Galv	Sencote	Glued	5M	M11BABN
7/8"	Chisel	Galv	Sencote	Glued	5M	M12BAB
1"	Chisel	Galv	Sencote	Glued	5M	M13BAB
1 1/4"	Chisel	Galv	Sencote	Glued	10M	M15BAB
1 1/2"	Chisel	Galv	Sencote	Glued	10M	M17BAB

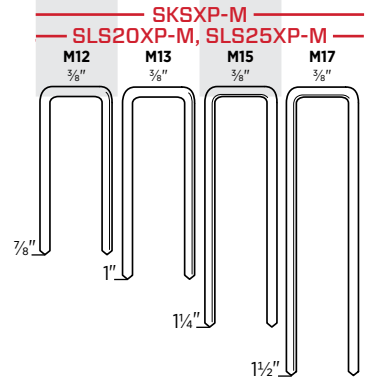
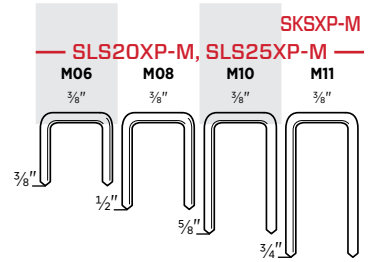

16
N

7/16" Crown Heavy Wire Staples

Cabinets, casebacks, drawers, upholstery, soffits, underlayment, lattice and sheathing						
Length	Point	Finish	Coating	Collation	Box Count	Item Code
3/4"	Chisel	Bright	Sencote	Glued	5M	N11BRB
1"	Chisel	Bright	Sencote	Glued	5M	N13BRB
1 1/8"	Chisel	Bright	Sencote	Taped	10M	N14BRB
1 1/4"	Chisel	Bright	Sencote	Taped	10M	N15BRB
1 3/8"	Chisel	Bright	Sencote	Taped	10M	N16BRB
1 1/2"	Chisel	Bright	Sencote	Taped	10M	N17BRB
1 5/8"	Chisel	Bright	Sencote	Taped	10M	N18BRB
1 3/4"	Chisel	Bright	Sencote	Taped	10M	N19BRB
2"	Chisel	Bright	Sencote	Taped	10M	N21BRB
1/2"	Chisel	Galv	Sencote	Taped	5M	N08BABN
1/2"	Chisel	Galv*	Sencote	Glued	5M	N08BBBN
1/2"	Diverg	Galv*	Sencote	Glued	5M	N08FBB
5/8"	Chisel	Galv	Sencote	Glued	5M	N10BAB
3/4"	Chisel	Galv	Sencote	Glued	5M	N11BAB
3/4"	Diverg	Galv*	Sencote	Glued	5M	N11FBB
7/8"	Chisel	Galv	Sencote	Glued	5M	N12BABN
7/8"	Diverg	Galv	Sencote	Glued	5M	N12FABN
1"	Chisel	Galv	Sencote	Glued	5M	N13BAB
1"	Diverg	Galv	Sencote	Glued	5M	N13FAB
1 1/8"	Chisel	Galv	Sencote	Taped	10M	N14BAB
1 1/4"	Chisel	Galv	Sencote	Taped	10M	N15BAB
1 1/4"	Diverg	Galv	Sencote	Glued	10M	N15FAB
1 3/8"	Chisel	Galv	Sencote	Taped	10M	N16BAB
1 1/2"	Chisel	Galv	Sencote	Taped	10M	N17BAB
1 5/8"	Chisel	Galv	Sencote	Taped	10M	N18BAB
1 3/4"	Chisel	Galv	Sencote	Taped	10M	N19BAB
2"	Chisel	Galv	Sencote	Taped	10M	N21BAB
1 1/4"	Chisel	Stainless 304	Sencote	Glued	3M	N15BGB
1 1/2"	Chisel	Stainless 304	Sencote	Glued	3M	N17BGB
1 3/4"	Chisel	Stainless 304	Sencote	Glued	3M	N19BGBN
2"	Chisel	Stainless 304	Sencote	Glued	3M	N21BGBN

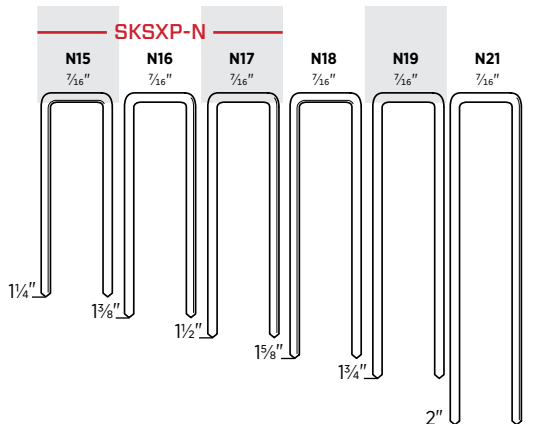
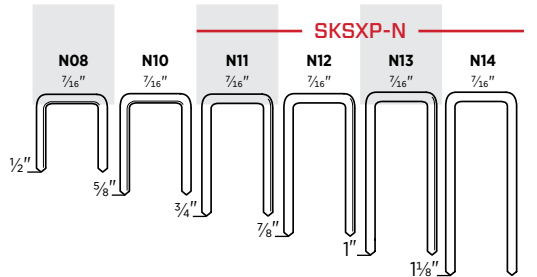

*Galvanized High Tensile

FINISH & WOODWORKING FASTENERS

25 GA
SENCOR

Sencor® 1" Crown Corrugated Fastener

Butt and miter joints

Length	Point	Finish	Coating	Collation	Box Count	Item Code
¼"	Sharp Chisel	Bright	Plain	Glued	8M	X04NRA
⅜"	Sharp Chisel	Bright	Plain	Glued	5M	X06NRA
½"	Sharp Chisel	Bright	Plain	Glued	4M	X08NRA

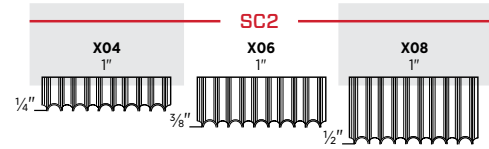

SENCOR® CORRUGATED FASTENERS

Sencor corrugated fasteners provide twice the joint strength of ordinary fasteners. Available in 1" crown and ¼", ⅜" and ½" lengths to ensure maximum joint strength. Use this fastener for butt and miter joints, truss construction, wooden boxes, pallet repair, cabinet and furniture frames.



25 GA
SENCLAMP

Senclamp® 7/16" Crown Joint Fastener

Butt and miter joints

Length	Point	Finish	Coating	Collation	Box Count	Item Code
5/16"	Chisel	Bright	Plain	Taped	3M	Y05BFA
7/16"	Chisel	Bright	Plain	Taped	3M	Y07BFA
9/16"	Chisel	Bright	Plain	Taped	3M	Y09BFA

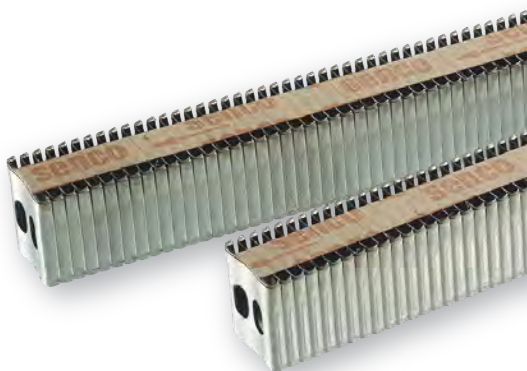
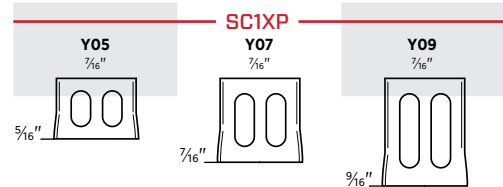

SENCLAMP® JOINT FASTENERS

Senclamp has a special webbed design that draws the material together as it drives through it. Made from carbon steel, fasteners are available in 7/16" crown and 5/16", 7/16" and 9/16" lengths to best suit your requirements. Designed for a wide range of joint fastening applications, Senclamp secures joints better, faster and for less.

FRAMING, SHEATHING & SUBFLOOR

NAILING THE RIGHT BALANCE OF SIZE, WEIGHT AND POWER

We offer a large selection of pneumatic and cordless nailers for a wide variety of applications.

APPLICATIONS

Framing, sheathing, truss building, installing subflooring, decking or fencing, assembling boxes or making pallets

KEY FEATURES

- Low profile designs allow for easy access between studs and joists
- Highly efficient internal design for increased durability
- Dry fire lock out prevents dry firing and signals user when to reload
- Claw-like safety for precise toe-nailing



F-35XP

CORDLESS PNEUMATIC FRAMING NAILER

ITEM #10G0002N



30°

Features

- FUSION® cordless air-power technology
- Pressure relief valve & refillable air port
- Brushless motor
- Includes one Li-ion battery, quick charge battery charger and storage bag
- Extended length magazine available, sold separately (see below)

F-35FRHXP

CORDLESS PNEUMATIC FRAMING NAILER

ITEM #10H0002N



21°

Features

- FUSION® cordless air-power technology
- Pressure relief valve & refillable air port
- Brushless motor
- Includes one Li-ion battery, quick charge battery charger and storage bag
- Extended length magazine available, sold separately (see below)

Extended Length Magazines

FOR 21° & 30° CORDLESS PNEUMATIC FRAMING NAILERS

Designed to hold two strips of nails, these extended length magazines replace the stock magazine and are easy to attach with the included Allen wrench.

Extended Length Magazine	Fits
GA0767	F-35XP
GA0778	F-35FRHXP



Product Reference Chart

TOOL SPECS	F-35XP	F-35FRHXP
Trigger	Selectable	Selectable
Technology	FUSION®	FUSION®
Power Type	Cordless	Cordless
Weight (with Battery)	11.37 lbs (5.16 kg)	11.38 lbs (5.17 kg)
Height	14.4" (366 mm)	14.4" (366 mm)
Length	14.0" (356 mm)	14.6" (371 mm)
Width	5.5" (140 mm)	4.7" (119 mm)
Charge Time	50% in less than 20 minutes, 100% in less than 60 minutes	
Warranty	5 yrs	5 yrs
FASTENER SPECS	Fasteners are located on pages 39–42	
Range	2"–3½"	2"–3½"
Shank	.113"–.148"	.113"–.131"
Capacity	60	35
Angle/Collation	30–34° Angled Paper Tape Strip	20–21° Angled Plastic Strip
Series	GC, GE, HC, HE, HF, KC ProHead G5, G6, H5, H6, K5, K6	GD, GL, HD, HL, KD, MD
TOOL FEATURES		
Depth-of-Drive	Yes, Tool-Free	Yes, Tool-Free
Rafter Hook	Yes	Yes
Dry Fire Lockout	Yes	Yes

FN91T1

3½" PAPER TAPE FRAMING NAILER



30°

Features

- Best in class tool power & durability
- Well-balanced ergonomic design
- In-line magazine for optimal line of sight
- Aggressive toenail safety
- Tool-free depth of drive



FN81T1

3½" FULL ROUND HEAD FRAMING NAILER



21°

Features

- Best in class tool power & durability
- Well-balanced ergonomic design
- In-line magazine for optimal line of sight
- Aggressive toenail safety
- Tool-free depth of drive



The New Standard in Framing

The FN81T1 and FN91T1 deliver the power and durability demanded by professional contractors for all-day performance on the toughest jobsites. Upgraded features include an ergonomic design, an in-line magazine for clear line of sight, and a tool-free depth of drive for quick adjustments.



Product Reference Chart

TOOL SPECS	FN91T1	FN81T1
Trigger	Sequential	Sequential
Operating Pressure	70-120 psi (4.8-8.3 bar)	70-120 psi (4.8-8.3 bar)
Air Consumption (60 CPM)	6.7 scfm	6.7 scfm
Air Inlet	¾" NPT	¾" NPT
Weight	8.39 lbs (3.8 kg)	8.75 lbs (3.9 kgs)
Height	14.13" (358 mm)	14.13" (358 mm)
Length	17.25" (438 mm)	20.75" (527 mm)
Width	4.88" (123 mm)	4.88" (123 mm)
Main Body Material	Aluminum	Aluminum
Warranty	5 yrs	5 yrs
FASTENER SPECS	Fasteners are located on pages 39-40	
Range	2" or 3½"	2" or 3½"
Shank	.113"-.135"	.113"-.148"
Capacity	80	70
Angle/Collation	30-34° Angled Paper Tape Strip	20-21° Angled Plastic Strip
Series	ProHead G5, H5, K5, G6, H6, K6 Clipped Head GC, GE, HC, HE, HF, KC, LC	GD, HD, KD, MD, GL, HL
TOOL FEATURES		
Depth-of-Drive	Yes, Tool-Free	Yes, Tool-Free
Rafter Hook	Yes	Yes
Dry Fire Lockout	Yes	Yes

FramePro®325XP

3/4" PAPER TAPE FRAMING NAILER

ITEM #4Z0101N



30°

Features

- Patented TrueDrive magazine reduces jams and misfeeds
- Efficient internal design means less wear and tear on the compressor
- Claw-like toenail safety
- Fits easily between studs and joists

FramePro®701XP

3/2" PAPER TAPE FRAMING NAILER

ITEM #2H0133N



30°

Features

- In-line magazine for optimal line of sight
- Simple two-step loading
- Claw-like toenail safety
- Fits easily between studs and joists

FramePro®751XP

3/2" PAPER TAPE FRAMING NAILER

ITEM #2J0103N



30°

Features

- In-line magazine for optimal line of sight
- Simple two-step loading
- Claw-like toenail safety
- Fits easily between studs and joists

Magazine Retrofit Kit (Sold Separately)

Updated magazine options		
FITS TOOLS	DESCRIPTION	ITEM #
FramePro701XP	2-Nail Strip Magazine Retrofit Kit	YJ0055
FramePro701XP	Double Length Magazine Retrofit Kit	YJ0043
FramePro751XP	4" Nail Feed System Retrofit Kit	YJ0042

Product Reference Chart

TOOL SPECS	FramePro®325XP	FramePro®701XP	FramePro®751XP
Trigger	Selectable	Sequential	Sequential
Operating Pressure	70-120 psi (4.8-8.3 bar)	70-120 psi (4.8-8.3 bar)	70-120 psi (4.8-8.3 bar)
Air Consumption (60 CPM)	5.2 scfm	10 scfm	11 scfm
Air Inlet	3/8" NPT	3/8" NPT	3/8" NPT
Weight	7.9 lbs (3.58 kg)	8 lbs (3.62 kg)	8.4 lbs (3.8 kg)
Height	11.9" (302 mm)	13.25" (337 mm)	14.25" (362 mm)
Length	17.3" (440 mm)	15.13" (384 mm)	15.13" (384 mm)
Width	4.5" (114 mm)	4.17" (106 mm)	4.17" (106 mm)
Main Body Material	Aluminum	Aluminum	Aluminum
Warranty	5 yrs	5 yrs	5 yrs
FASTENER SPECS	Fasteners are located on pages 39-40		
Range	2"-3 1/4"	2"-3 1/2"	2"-3 1/2"
Shank	.113"-.148"	.113"-.135"	.113"-.148"
Capacity	83	70	70
Angle/Collation	30-34° Angled Paper Tape Strip	30-34° Angled Paper Tape Strip	30-34° Angled Paper Tape Strip
Series	GC, GE, HC, HE, HF, KC ProHead G5, G6, H5, H6, K5, K6	GC, GE, HC, HE, HF, KC ProHead G5, G6, H5, H6, K5, K6	GC, GE, HC, HE, HF, KC, LC ProHead G5, G6, H5, H6, K5, K6
TOOL FEATURES			
Depth-of-Drive	Yes, Tool-Free	Yes, Tool-Free	Yes, Tool-Free
Rafter Hook	Yes	Yes	Yes
Dry Fire Lockout	Yes	Yes	Yes

FramePro®325FRHXP

3¼" FULL ROUND HEAD FRAMING NAILER

ITEM #4H0101N



21°

Features

- Patented TrueDrive magazine reduces jams and misfeeds
- Effective internal design means less wear and tear on the compressor
- Claw-like toenail safety
- Fits easily between studs and joists

FramePro®752XP

3½" FULL ROUND HEAD FRAMING NAILER

ITEM #2F0103N



21°

Features

- 21° in-line magazine provides excellent maneuverability and line of sight
- Simple two-step loading
- Claw-like toenail safety
- Fits easily between studs and joists

FramePro®702XP

3½" FULL ROUND HEAD FRAMING NAILER

ITEM #2K0103N



21°

Features

- 21° in-line magazine provides excellent maneuverability and line of sight
- Simple two-step loading
- Claw-like toenail safety
- Fits easily between studs and joists

Product Reference Chart

TOOL SPECS	FramePro®325FRHXP	FramePro®702XP	FramePro®752XP
Trigger	Selectable	Sequential	Sequential
Operating Pressure	70-120 psi (4.8-8.3 bar)	70-120 psi (4.8-8.3 bar)	70-120 psi (4.8-8.3 bar)
Air Consumption (60 CPM)	5.2 scfm	10 scfm	11 scfm
Air Inlet	¾" NPT	¾" NPT	¾" NPT
Weight	7.9 lbs (3.58 kg)	8.4 lbs (3.8 kg)	8.7 lbs (3.97 kg)
Height	11.9" (302 mm)	13.25" (337 mm)	14.25" (362 mm)
Length	17.3" (440 mm)	20" (508 mm)	20" (508 mm)
Width	4.5" (114 mm)	4.17" (106 mm)	4.17" (106 mm)
Main Body Material	Aluminum	Aluminum	Aluminum
Warranty	5 yrs	5 yrs	5 yrs
FASTENER SPECS	Fasteners are located on page 41-42		
Range	2"-3¼"	2"-3½"	2"-3½"
Shank	.113"-.148"	.113"-.148"	.120"-.162"
Capacity	64	60	60
Angle/Collation	20-21° Angled Plastic Strip	20-21° Angled Plastic Strip	20-21° Angled Plastic Strip
Series	GD, GL, HD, HL, HK, KD, KL, MD	GD, GL, HD, HL, KD, MD	GD, GL, HD, HL, KD, MD
TOOL FEATURES			
Depth-of-Drive	Yes, Tool-Free	Yes- Tool Free	Yes, Tool-Free
Rafter Hook	Yes	Yes	Yes
Dry Fire Lockout	Yes	Yes	Yes

SCN60XP

2¾" COIL NAILER

ITEM #520101N



15°
COIL

Features

- High load capacity
- EZ-Load design saves time
- Fast cycle time increases productivity
- Lightweight for comfortable all-day use

Mini Hand Nailer

2"-3½" BULK NAILER

ITEM #PC1195



Features

- Compact and powerful enough to drive 2"-3½" bulk nails
- Magnetic nose holds nail in place for safe, accurate placement
- Ultra-light at just 1 pound

SCN65XP

3½" COIL NAILER

ITEM #540101N - FLAT SAFETY; 540104N - TOENAIL SAFETY



15°
COIL

Features

- High load capacity
- EZ-Load design saves time
- Fast cycle time increases productivity
- Light and fast for greater productivity

A20 Hand Nailer

2"-7" BULK NAILER

ITEM #PC0781



Features

- Drives bulk nails from 2"-7"
- Soft rubber palm pad for comfortable grip
- Magnetic nose holds nail in place for safe, accurate placement
- Includes leather strap for comfort

Product Reference Chart

TOOL SPECS	SCN60XP	SCN65XP	Mini Hand Nailer	A20 Hand Nailer
Trigger	Contact	Contact	—	—
Operating Pressure	70-120 psi (4.8-8.3 bar)	70-120 psi (4.8-8.3 bar)	60-110 psi (4-7.6 bar)	50-125 psi (3.5-8.4 bar)
Air Consumption (60 CPM)	8.29 scfm	9.54 scfm	2-4 scfm	2-4 scfm
Air Inlet	¾" NPT	¾" NPT	¼" NPT	¾" NPT
Weight	7.5 lbs (3.4 kg)	8 lbs (3.6 kg)	1 lb (.45 kg)	2.4 lbs (1.1 kg)
Height	12.38" (314 mm)	14.1" (359 mm)	4" (101 mm)	5.8" (122 mm)
Length	12.88" (327 mm)	12.88" (327 mm)	2.75" (70 mm)	4" (101 mm)
Width	5.38" (137 mm)	5.38" (137 mm)	2" (55.6 mm)	3.25" (83 mm)
Main Body Material	Aluminum	Aluminum	Aluminum	Aluminum
Warranty	5 yrs	5 yrs	1 yr	1 yr
FASTENER SPECS	Fasteners are located on pages 42-44			
Range	2"-2¾"	2"-3½"	Bulk nails from 2"-3½"	Bulk nails from 2"-3½" up to 7" with opt. guide tips
Shank	.099"-.113"	.099"-.131"	—	.113"-.148"
Capacity	250-275	225-275	1	1
Angle/Collation	15° Flat Wire Welded Coil	15° Flat Wire Welded Coil	—	—
Series	BK, BL, BT, GD, GL, HR	BJ, BK, BL, BT, GD, GL, HD, HK, HL, KD	—	—
TOOL FEATURES				
Depth-of-Drive	Yes, Tool-Free	Yes, Tool-Free	—	—
Rafter Hook	No	No	—	—
Dry Fire Lockout	No	No	—	—

JN91H1

1½" METAL CONNECTOR NAILER



Features

- Lightweight and well-balanced for comfortable all day use
- Power to drive through engineered lumber
- Leads with the nail to locate metal connector holes, providing accurate nail placement
- Dry fire lockout reduces tool wear and indicates the need to reload fasteners

JN91H2

1½" METAL CONNECTOR NAILER



Features

- Extended magazine holds two racks of nails
- Lightweight and well-balanced for comfortable all day use
- Power to drive through engineered lumber
- Leads with the nail to locate metal connector holes, providing accurate nail placement
- Dry fire lockout reduces tool wear and indicates the need to reload fasteners

JN91P1

1½"-2½" METAL CONNECTOR NAILER



Features

- Lightweight and well-balanced for comfortable all day use
- Power to drive through engineered lumber
- Nosepiece probe locates metal connector holes, providing accurate nail placement
- Dry fire lockout reduces tool wear and indicates the need to reload fasteners

JN91P2

1½"-2½" METAL CONNECTOR NAILER



Features

- Extended magazine holds two racks of nails
- Lightweight and well-balanced for comfortable all day use
- Power to drive through engineered lumber
- Nosepiece probe locates metal connector holes, providing accurate nail placement
- Dry fire lockout reduces tool wear and indicates the need to reload fasteners

Product Reference Chart

TOOL SPECS	JN91H1	JN91H2	JN91P1	JN91P2
Trigger	Sequential	Sequential	Sequential	Sequential
Operating Pressure	70-120 psi (4.8-8.3 bar)	70-120 psi (4.8 - 8.3 bar)	70-120 psi (4.8-8.3 bar)	70-120 psi (4.8 - 8.3 bar)
Air Consumption (60 CPM)	4.4 scfm	4.4 scfm	6.4 scfm	6.4 scfm
Air Inlet	¼" NPT	¼" NPT	¼" NPT	¼" NPT
Weight	5.48 lbs (2.48 kg)	5.8 lbs (2.63 kg)	7.53 lbs (3.41 kg)	7.92 lbs (3.59 kg)
Height	12.5" (317 mm)	12.5" (317 mm)	14.38" (365 mm)	14.38" (365 mm)
Length	11.13" (282 mm)	17.86" (453 mm)	14" (355 mm)	19" (482 mm)
Width	4.38" (111 mm)	4.88" (123 mm)	5.25" (133 mm)	6.13" (155 mm)
Main Body Material	Magnesium	Magnesium	Magnesium	Magnesium
Warranty	5 yrs	5 yrs	5 yrs	5 yrs
FASTENER SPECS	Fasteners are located on page 45			
Range	1½"	1½"	1½"-2½"	1½"-2½"
Shank	.131"-.148"	.131"-.148"	.131"-.162"	.131"-.162"
Capacity	30	55	35	55
Angle/Collation	34° Paper Tape Strip	34° Paper Tape Strip	34° Paper Tape Strip	34° Paper Tape Strip
Series	KJ, MD	KJ, MD	KJ, MD, ND	KJ, MD, ND
TOOL FEATURES				
Depth-of-Drive	No	No	Yes	Yes
Rafter Hook	Yes	Yes	Yes	Yes
Dry Fire Lockout	Yes	Yes	Yes	Yes

SCP40XP

1½" STANDARD PRESSURE PNEUMATIC CONCRETE & STEEL PINNER

ITEM #7J0009N



Features

- 10 times faster than powder-actuated systems
- No licensing required to operate
- Works with conventional air compressors, hoses and fittings
- Operates at extreme temperatures and altitudes

PS20XP

1" WIDE CROWN, 2" HEAVY WIRE STAPLER

ITEM #9W0001N



Features

- Enhanced quick clear latch allows for quick access to clear fasteners
- Updated aggressive locking feature provides superior holding power for complete control of the fastener, offering pinpoint accuracy and unrivaled driveability
- New drive track design eliminates movement of the staple, enhancing overall drive performance and virtually eliminating fastener jams, skipping and misfires

PS15XP

1" WIDE CROWN, 1½" HEAVY WIRE STAPLER

ITEM #9T0001N



Features

- Enhanced quick clear latch allows for quick access to clear fasteners and a new locking feature offers pinpoint accuracy and unrivaled driveability
- Updated drive track eliminates staple movement, virtually eliminating jams
- Robust firing valve design makes the tool fast, powerful and efficient
- Positive-locking adjustable depth-of-drive ensures consistently flush drives

Concrete Pinner

Plaster, stucco & building wrap fastening attachment

	Fits Tools	Range	ITEM #	
SENCO	SCP40XP	1¼"	NPC035	 Magnetic washer nosepiece

Galvanized Metal Washer

ITEM #	Diameter	Box Count	Fits SCP40XP, GT40CP
SWM125B	1¼"	1M	.109" Dia. Concrete Pins



Feed System Retrofit Kit (Sold Separately)

Updated feed system option

CONVERTS	ITEM #
WC150 to PS15XP	YJ0044

Product Reference Chart

TOOL SPECS	SCP40XP	PS15XP	PS20XP
Trigger	Sequential	Contact	Contact
Operating Pressure	80-120 psi (5.5-8.3 bar)	70-120 psi (4.8-8.3 bar)	70-120 psi (4.8-8.3 bar)
Air Consumption (60 CPM)	5.2 scfm	3.18 scfm	3.45 scfm
Air Inlet	¾" NPT	¾" NPT	¾" NPT
Weight	7.1 lbs (3.2 kg)	5.5 lbs (2.5 kg)	5.5 lbs (2.5 kg)
Height	12.22" (310 mm)	9" (229 mm)	10" (254 mm)
Length	18.2" (462 mm)	15.25" (387 mm)	15.25" (387 mm)
Width	4.5" (114.4 mm)	5.5 lbs (2.5 kg)	3.5" (89 mm)
Main Body Material	Aluminum	Aluminum	Aluminum
Warranty	5 yrs	5 yrs	5 yrs
FASTENER SPECS	Fasteners are located on pages 45-47		
Shank/Crown	.109"/.118" Shanks	1" Crown	1" Crown
Range	½"-1½"	⅝"-1½"	⅞"-2"
Capacity	42	160	160
Angle/Collation	Straight Plastic Collated Strip	Taped and taped glued	Straight Glued and Taped Strip
Series	W3	P	P
TOOL FEATURES			
Depth-of-Drive	No	Yes, Tool-Free	Yes, Tool-Free
Belt Hook	No	Yes	Yes
Dry Fire Lockout	Yes	No	No

NS20XP

7/16" CROWN, 2" HEAVY WIRE STAPLER

ITEM #9X0001N



16^{GA}
N

Features

- 15% more powerful than all other construction staplers in its class
- Enhanced quick clear latch allows for quick access to clear fasteners
- Updated aggressive locking feature
- Drive track design eliminates movement of the staple
- Can also be used for vinyl siding installation (item number HC0788 required, sold separately)

SNS41

7/16" CROWN, 2" HEAVY WIRE STAPLER

ITEM #3L0003N



16^{GA}
N

Features

- Durable construction minimizes downtime and operating costs
- Quick clear latch virtually eliminates downtime caused by fastener jams
- Fast, multidirectional stitching

NS20BXP

7/16" CROWN, HEAVY WIRE STAPLER

ITEM #9Y0001N



16^{GA}
N

Features

- 20% more powerful than the standard NS20XP for the most demanding applications
- Enhanced quick clear latch allows for quick access to clear fasteners
- Updated aggressive locking feature
- Can also be used for vinyl siding installation (item number HC0788 required, sold separately)

SQS55XP

7/16" CROWN, 2 1/2" HEAVY WIRE STAPLER

ITEM #660101N



15^{GA}
Q

Features

- Fast — up to 15 staples per second
- Quick clear latch virtually eliminates downtime caused by fastener jams
- Rugged dependability

Product Reference Chart

TOOL SPECS	NS20XP	NS20BXP	SNS41	SQS55XP
Trigger	Contact	Contact	Contact	Contact
Operating Pressure	70–120 psi (4.8–8.3 bar)	70–120 psi (4.8–8.3 bar)	80–120 psi (5.5–8.3 bar)	80–120 psi (5.5–8.3 bar)
Air Consumption (60 CPM)	3.5 scfm	3.98 scfm	5.4 scfm	6.54 scfm
Air Inlet	3/8" NPT	3/8" NPT	3/8" NPT	3/8" NPT
Weight	5.1 lbs (2.3 kg)	5.8 lbs (2.6 kg)	4.6 lbs (2.1 kg)	5.9 lbs (2.7 kg)
Height	11" (279 mm)	11" (279 mm)	10.75" (273 mm)	12" (305 mm)
Length	15" (381 mm)	15" (381 mm)	15" (381 mm)	14.38" (365 mm)
Width	3.5" (89 mm)	4" (102 mm)	3.4" (86 mm)	3.6" (92 mm)
Main Body Material	Aluminum	Aluminum	Aluminum	Aluminum
Warranty	5 yrs	5 yrs	5 yrs	5 yrs
FASTENER SPECS	Fasteners are located on pages 46–47			
Crown	7/16"	7/16"	7/16"	7/16"
Range	1"–2"	1"–2"	1"–2"	1 1/4"–2 1/2"
Capacity	160	160	160	130
Angle/Collation	Straight Glued and Taped Strip	Straight Glued and Taped Strip	Straight Glued and Taped Strip	Straight Glued and Taped Strip
Series	N	N	N	Q
TOOL FEATURES				
Depth-of-Drive	Yes, Tool-Free	Yes, Tool-Free	Yes, Tool-Required	Yes, Tool-Required
Belt Hook	Yes	Yes	No	No
Dry Fire Lockout	No	No	No	No

FRAMING, SHEATHING & SUBFLOOR FASTENERS

30°

ProHead® Smooth Shank Paper Tape Nails

Framing, sheathing, subfloor, decks, trusses and pallets						
Length	Point	Finish	Coating	Collation	Box Count	Item Code
2 3/8" x .113"	Diamond	Bright	Sencote	30° Paper Tape Strip	2.5M	G524APBXN
3" x .120"	Diamond	Bright	Sencote	30° Paper Tape Strip	2.5M	H527APBXN
3 1/4" x .120"	Diamond	Bright	Sencote	30° Paper Tape Strip	2.5M	H528APBXN
2 1/2" x .131"	Diamond	Bright	Sencote	30° Paper Tape Strip	2M	K525APBXN
3" x .131"	Diamond	Bright	Sencote	30° Paper Tape Strip	2.5M	K527APBXN
3" x .131"	Diamond	Bright	Sencote	30° Paper Tape Strip	0.5M	K527APBXR
3 1/4" x .131"	Diamond	Bright	Sencote	30° Paper Tape Strip	2.5M	K528APBXN
3 1/4" x .131"	Diamond	Bright	Sencote	30° Paper Tape Strip	0.5M	K528APBXR
3 1/2" x .131"	Diamond	Bright	Sencote	30° Paper Tape Strip	2.5M	K529APBXN
2 3/8" x .113"	Diamond	Hot Dip	Sencote	30° Paper Tape Strip	2.5M	G524ASBXN
3" x .131"	Diamond	Hot Dip	Sencote	30° Paper Tape Strip	2.5M	K527ASBXN
3 1/4" x .131"	Diamond	Hot Dip	Sencote	30° Paper Tape Strip	2.5M	K528ASBXN
3" x .120"	Diamond	Bright	Sencote	30° Paper Tape Strip	1M	H527APBXNR
3" x .131"	Diamond	Bright	Sencote	30° Paper Tape Strip	1M	K527APBXNR
3 1/4" x .131"	Diamond	Bright	Sencote	30° Paper Tape Strip	1M	K528APBXNR
3" x .131"	Diamond	Hot Dip	Sencote	30° Paper Tape Strip	1M	K527ASBXNR
3 1/4" x .131"	Diamond	Hot Dip	Sencote	30° Paper Tape Strip	1M	K528ASBXNR

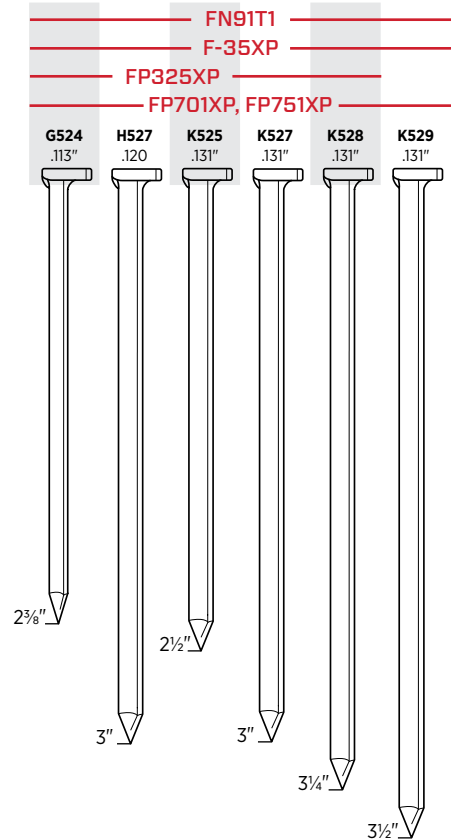

30°

ProHead® Ring Shank Paper Tape Nails

Framing, sheathing, subfloor, decks, trusses and pallets						
Length	Point	Finish	Coating	Collation	Box Count	Item Code
2 3/8" x .113"	Diamond	Bright	Sencote	30° Paper Tape Strip	2.5M	G624APBXN
3" x .120"	Diamond	Bright	Sencote	30° Paper Tape Strip	2.5M	H627APBXN
3 1/4" x .131"	Diamond	Bright	Sencote	30° Paper Tape Strip	2.5M	K628APBXN
2" x .113"	Diamond	Hot Dip	Sencote	30° Paper Tape Strip	2.5M	G621ASBXN
2 3/8" x .113"	Diamond	Hot Dip	Sencote	30° Paper Tape Strip	2.5M	G624ASBXN
3" x .120"	Diamond	Hot Dip	Sencote	30° Paper Tape Strip	2.5M	H627ASBXN
3" x .131"	Diamond	Hot Dip	Sencote	30° Paper Tape Strip	2.5M	K627ASBXN
3 1/4" x .131"	Diamond	Hot Dip	Sencote	30° Paper Tape Strip	2.5M	K628ASBXN
3 1/2" x .131"	Diamond	Hot Dip	Sencote	30° Paper Tape Strip	2.5M	K629ASBXN
2 3/8" x .113"	Diamond	Bright	Sencote	30° Paper Tape Strip	1M	G624ASBXNR
3" x .120"	Diamond	Bright	Sencote	30° Paper Tape Strip	1M	H627ASBXNR

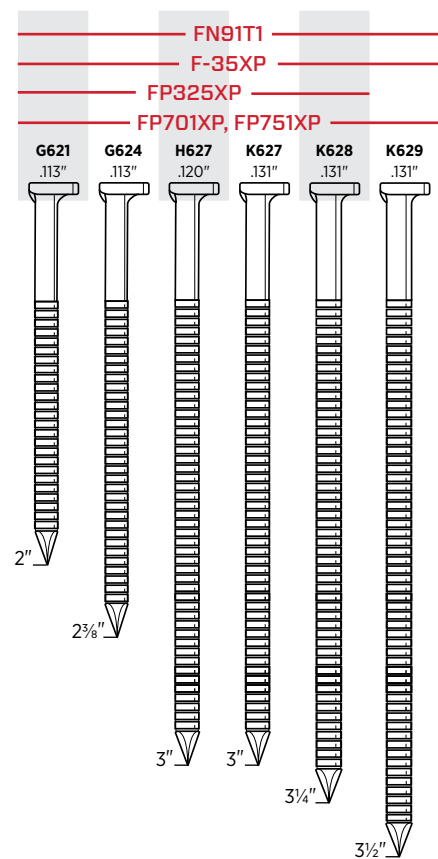

FRAMING, SHEATHING & SUBFLOOR FASTENERS

30°

Smooth Shank Paper Tape Collated Nails

Framing, sheathing, subfloor, decks, trusses and pallets						
Length	Point	Finish	Coating	Collation	Box Count	Item Code
2¼" x .113"	Diamond	Bt. Hardened	Plain	30° Paper Tape Strip	1M	GC23AHAK
2" x .113"	Diamond	Bright	Sencote	30° Paper Tape Strip	2.5M	GC21APBX
2⅝" x .113"	Diamond	Bright	Sencote	30° Paper Tape Strip	2.5M	GC24APBX
2½" x .113"	Diamond	Bright	Sencote	30° Paper Tape Strip	2.5M	GC25APBX
3" x .120"	Diamond	Bright	Sencote	30° Paper Tape Strip	2.5M	HC27APBX
3¼" x .120"	Diamond	Bright	Sencote	30° Paper Tape Strip	2.5M	HC28APBX
3" x .131"	Diamond	Bright	Sencote	30° Paper Tape Strip	2.5M	KC27APBX
3¼" x .131"	Diamond	Bright	Sencote	30° Paper Tape Strip	2.5M	KC28APBX
3½" x .131"	Diamond	Bright	Sencote	30° Paper Tape Strip	2.5M	KC29APBX
3½" x .135"	Diamond	Bright	Sencote	30° Paper Tape Strip	2.5M	LC29APBX
4" x .131"	Diamond	Bright	Sencote	30° Paper Tape Strip	2.5M	KC31APBX*
2⅝" x .113"	Diamond	Hot Dip	Sencote	30° Paper Tape Strip	2.5M	GC24ASBX
3" x .120"	Diamond	Hot Dip	Sencote	30° Paper Tape Strip	2.5M	HC27ASBX
3" x .131"	Diamond	Hot Dip	Sencote	30° Paper Tape Strip	2.5M	KC27ASBX
3¼" x .131"	Diamond	Hot Dip	Sencote	30° Paper Tape Strip	2.5M	KC28ASBX
3½" x .131"	Diamond	Hot Dip	Sencote	30° Paper Tape Strip	2.5M	KC29ASBX
3" x .131"	Diamond	Stainless 304	Sencote	30° Paper Tape Strip	1M	KC27AGBK
3¼" x .131"	Diamond	Stainless 304	Sencote	30° Paper Tape Strip	1M	KC28AGBK

*FramePro®751XP can drive 4 inch nails when fitted with the YJ0042 kit

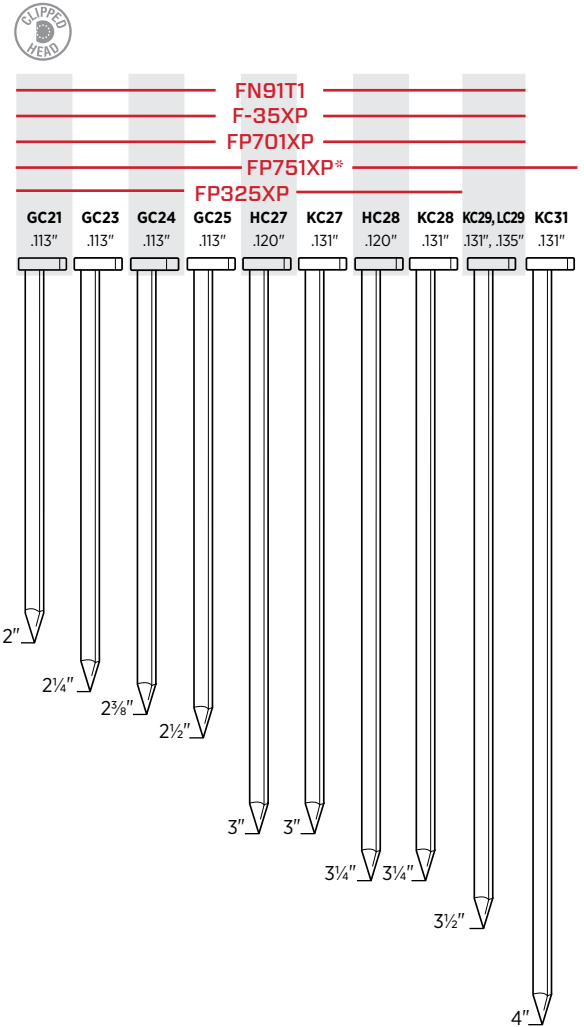

30°

Ring Shank Paper Tape Collated Nails

Framing, sheathing, subfloor, decks, trusses and pallets						
Length	Point	Finish	Coating	Collation	Box Count	Item Code
2" x .113"	Diamond	Bright	Plain	30° Paper Tape Strip	2.5M	GE21APAX
2⅝" x .113"	Diamond	Bright	Sencote	30° Paper Tape Strip	2.5M	GE24APBX
2" x .113"	Diamond	Hot Dip	Sencote	30° Paper Tape Strip	2.5M	GE21ASBX
2⅝" x .113"	Diamond	Hot Dip	Sencote	30° Paper Tape Strip	2.5M	GE24ASBX
3" x .120"	Diamond	Hot Dip	Sencote	30° Paper Tape Strip	2.5M	HE27ASBX
2⅝" x .113"	Diamond	Stainless 304	Sencote	30° Paper Tape Strip	1M	GE24AGBK

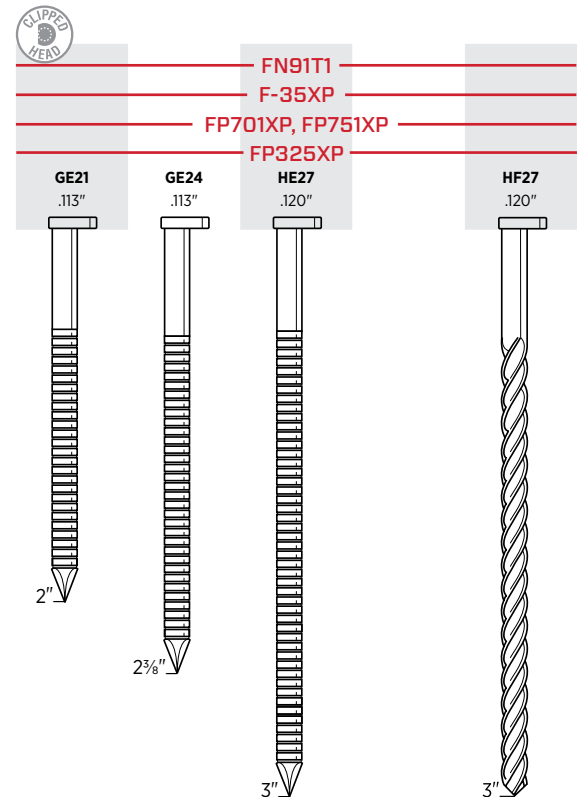

30°

Screw Shank Paper Tape Collated Nails

Framing, sheathing, subfloor, decks, trusses and pallets						
Length	Point	Finish	Coating	Collation	Box Count	Item Code
3" x .120"	Chisel	Bright	Plain	30° Paper Tape Strip	3.1M	HF27EPAK
3" x .120"	Chisel	Bright	Sencote	30° Paper Tape Strip	1M	HF27EDB

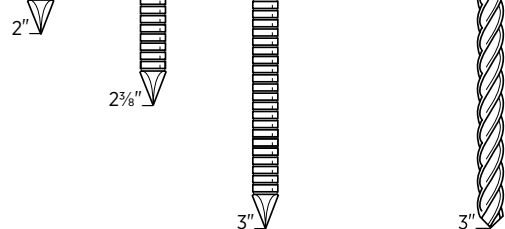

FRAMING, SHEATHING & SUBFLOOR FASTENERS

21°

Smooth Shank Plastic Collated Nails

Framing, sheathing, subfloor, decks, trusses and pallets

Length	Point	Finish	Coating	Collation	Box Count	Item Code
2 3/8" x .113"	Diamond	Bright	Sencote	21° Plastic Strip	5M	GD24APBSN
2 1/2" x .113"	Diamond	Bright	Sencote	21° Plastic Strip	5M	GD25APBSN
2 1/2" x .131"	Diamond	Bright	Sencote	21° Plastic Strip	4M	KD25APBSN
3" x .120"	Diamond	Bright	Sencote	21° Plastic Strip	4M	HD27APBSN
3" x .131"	Diamond	Bright	Sencote	21° Plastic Strip	4M	KD27APBSN
3" x .148"	Diamond	Bright	Sencote	21° Plastic Strip	4M	MD27APBSN
3 1/4" x .131"	Diamond	Bright	Sencote	21° Plastic Strip	4M	KD28APBSN
3 1/4" x .148"	Diamond	Bright	Sencote	21° Plastic Strip	4M	MD28APBSN
3 1/2" x .131"	Diamond	Bright	Sencote	21° Plastic Strip	4M	KD29APBSN
2 3/8" x .113"	Diamond	Hot Dip	Sencote	21° Plastic Strip	2.5M	GD24ASBS
2 1/2" x .113"	Diamond	Galv	Sencote	21° Plastic Strip	5M	GD25AABSNS
2 1/2" x .120"	Diamond	Exterior	Sencote	21° Plastic Strip	2.3M	HJ25ADBS*
2 1/2" x .131"	Diamond	Galv	Sencote	21° Plastic Strip	2.5M	KD25AABS
3" x .131"	Diamond	Hot Dip	Sencote	21° Plastic Strip	2.5M	KD27ASBS
3 1/4" x .131"	Diamond	Hot Dip	Sencote	21° Plastic Strip	2.5M	KD28ASBS
3 1/2" x .131"	Diamond	Hot Dip	Sencote	21° Plastic Strip	2.5M	KD29ASBS
3 1/4" x .131"	Diamond	Stainless 304	Sencote	21° Plastic Strip	1M	KD28AGBS
3" x .131"	Diamond	Bright	Sencote	21° Plastic Strip	1M	KD27APBSNR
3 1/4" x .131"	Diamond	Bright	Sencote	21° Plastic Strip	1M	KD28APBSNR
3" x .131"	Diamond	Hot Dip	Sencote	21° Plastic Strip	1M	KD27ASBSNR
3 1/4" x .131"	Diamond	Hot Dip	Sencote	21° Plastic Strip	1M	KD28ASBSNR

*Roof tile nails, drive with FramePro® 725XP or SN952XP

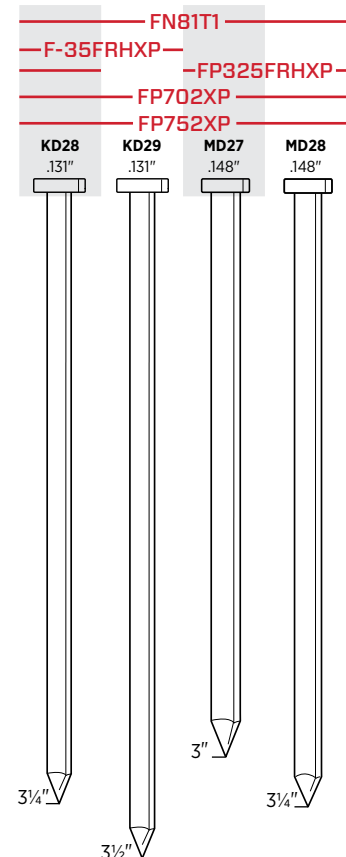
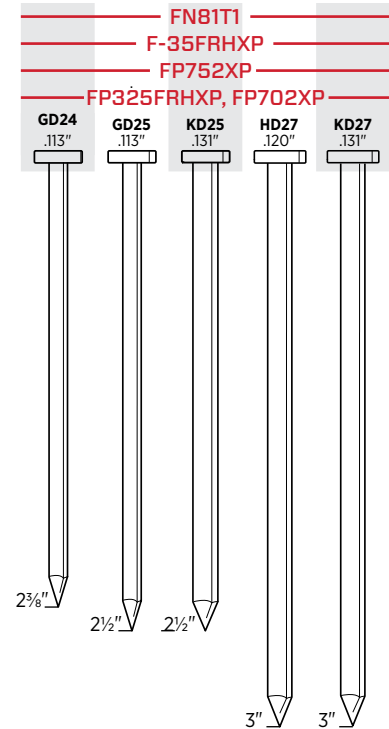

FRAMING, SHEATHING & SUBFLOOR FASTENERS

21° Ring Shank Plastic Collated Nails

Framing, sheathing, subfloor, decks, trusses and pallets						
Length	Point	Finish	Coating	Collation	Box Count	Item Code
2" x .113"	Diamond	Bright	Sencote	21° Plastic Strip	5M	GL21APBSN
2 3/8" x .113"	Diamond	Bright	Sencote	21° Plastic Strip	5M	GL24APBSN
2" x .113"	Diamond	Hot Dip	Sencote	21° Plastic Strip	2.5M	GL21ASBS
2 3/8" x .113"	Diamond	Galv	Sencote	21° Plastic Strip	5M	GL24AABSN
2 3/8" x .113"	Diamond	Hot Dip	Sencote	21° Plastic Strip	2.5M	GL24ASBS
3" x .120"	Diamond	Hot Dip	Sencote	21° Plastic Strip	2.5M	HL27ASBS
2 3/8" x .113"	Diamond	Stainless 304	Sencote	21° Plastic Strip	1M	GL24AGBS
3" x .120"	Diamond	Stainless 304	Sencote	21° Plastic Strip	1M	HL27AGBS
2 3/8" x .113"	Diamond	Hot Dip	Sencote	21° Plastic Strip	1M	GL24ASBSNR

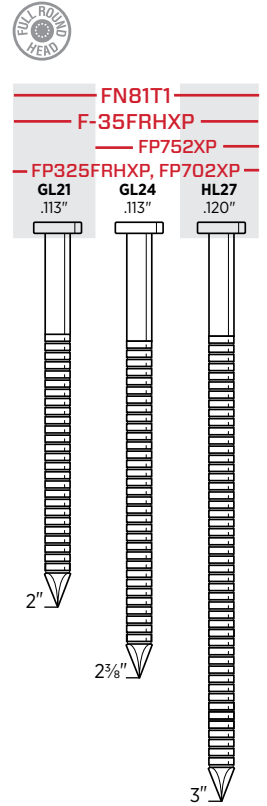

15° COIL Ring Shank Subflooring Nails

Superior fastening in subfloor applications						
Length	Point	Finish	Coating	Collation	Box Count	Item Code
2" x .099"	Diamond	Bright Basic	Sencote	15° Flat Wire Welded Coil	6.6M	BT21APBF
2 3/8" x .113"	Diamond	Bright Basic	Sencote	15° Flat Wire Welded Coil	4M	GT24APBF
2 1/2" x .131"	Diamond	Bright Basic	Sencote	15° Flat Wire Welded Coil	4M	KT25APBF

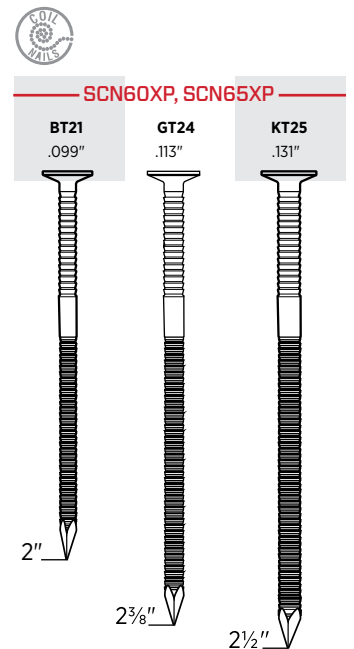

Subfloor and Sheathing Coil Nails

- Superior fastening in floor applications
- Tested and proven to reduce squeaky subfloors, uneven surfaces, and raised nail heads
- Unique double rings shank design reduces the potential of nails backing out, one of the most common flooring problems

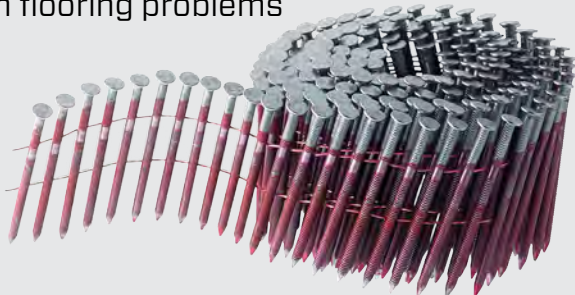

FRAMING, SHEATHING & SUBFLOOR FASTENERS

15°
COIL

Smooth Shank Coil Nails

Framing, sheathing, pallets, subfloor, decks and trusses

Length	Point	Finish	Coating	Collation	Box Count	Item Code
2" x .113"	Diamond	Bright	Sencote	15° Flat Wire Welded Coil	6M	GD21APBF
2½" x .113"	Diamond	Bright	Sencote	15° Flat Wire Welded Coil	6M	GD25APBF
2½" x .131"	Diamond	Bright	Sencote	15° Flat Wire Welded Coil	3.6M	KD25APBF
3" x .120"	Diamond	Bright	Sencote	15° Flat Wire Welded Coil	4M	HD27APBF
3" x .131"	Diamond	Bright	Sencote	15° Flat Wire Welded Coil	3.6M	KD27APBF
3¼" x .131"	Diamond	Bright	Sencote	15° Flat Wire Welded Coil	3.6M	KD28APBF
3½" x .131"	Diamond	Bright	Sencote	15° Flat Wire Welded Coil	3.6M	KD29APBF
5" x .148"	Diamond	Bright	Sencote	15° Flat Wire Welded Coil	1.8M	MD34APBF
2" x .113"	Diamond	Galv	Sencote	15° Flat Wire Welded Coil	6M	GD21AABF
2½" x .113"	Diamond	Galv	Sencote	15° Flat Wire Welded Coil	6M	GD25AABF
3" x .131"	Diamond	Hot Dip	Sencote	15° Flat Wire Welded Coil	2.4M	KD27ASBF
3¼" x .131"	Diamond	Hot Dip	Sencote	15° Flat Wire Welded Coil	2.4M	KD28ASBF

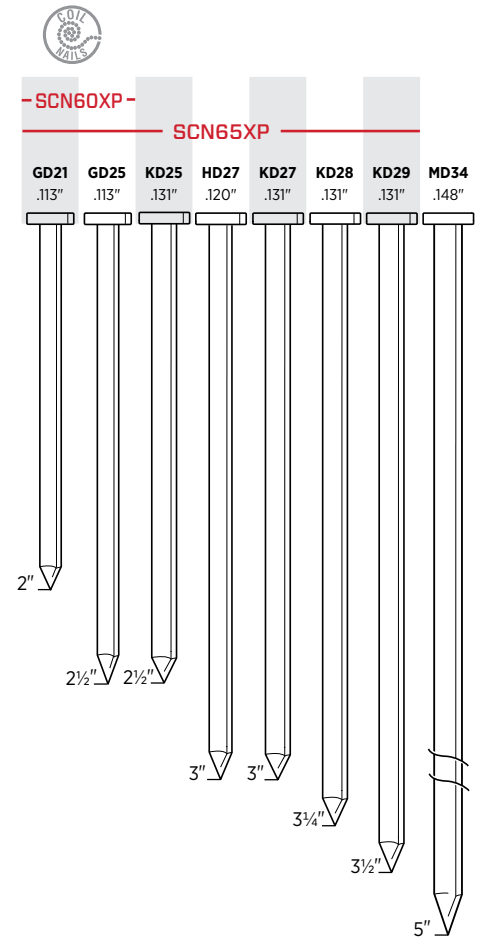

15°
COIL

Ring Shank Coil Nails

Framing, sheathing, pallets, subfloor, decks and trusses

Length	Point	Finish	Coating	Collation	Box Count	Item Code
2" x .099"	Diamond	Bright	Sencote	15° Flat Wire Welded Coil	6.6M	BL21APBF
2" x .099"	Diamond	Bright	Sencote	15° Flat Wire Welded Coil	6.6M	BT21APBF
2" x .113"	Diamond	Bright	Sencote	15° Flat Wire Welded Coil	6M	GL21APBF
2¾" x .113"	Diamond	Bright	Sencote	15° Flat Wire Welded Coil	6M	GL24APBF
2¼" x .099"	Diamond	Galv	Sencote	15° Flat Wire Welded Coil	6.6M	BE23AABF
2¾" x .113"	Diamond	Hot Dip	Sencote	15° Flat Wire Welded Coil	2.7M	GL24ASBF
3" x .120"	Diamond	Hot Dip	Sencote	15° Flat Wire Welded Coil	2.4M	HL27ASBF
2¾" x .113"	Diamond	Stainless 304	Sencote	15° Flat Wire Welded Coil	2.7M	GL24AGBF

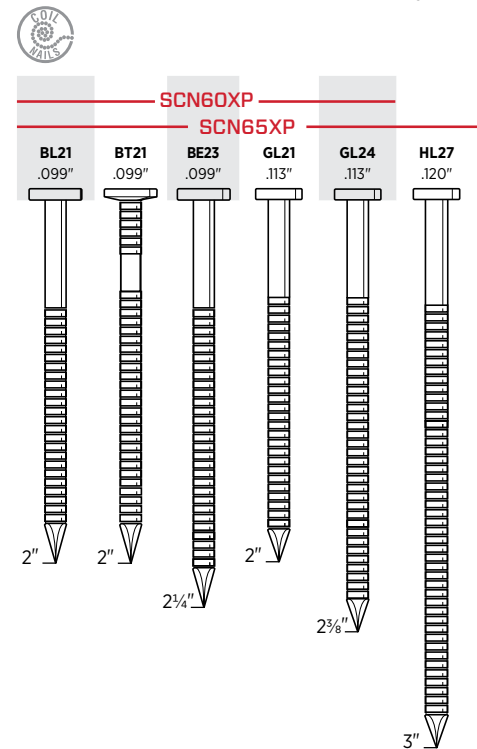

FRAMING, SHEATHING & SUBFLOOR FASTENERS

15°
COIL

Screw Shank Coil Nails

Framing, sheathing, pallets, subfloor, decks and trusses

Length	Point	Finish	Coating	Collation	Box Count	Item Code
2" x .099"	Blunt Dia.	Bright	Sencote	15° Flat Wire Welded Coil	9M	BK21BPBFN
2¼" x .099"	Blunt Dia.	Bright	Sencote	15° Flat Wire Welded Coil	9M	BK23BPBFN
2½" x .099"	Blunt Dia.	Bright	Sencote	15° Flat Wire Welded Coil	6M	BK25BPBFN
3" x .120"	Diamond	Bright	Sencote	15° Flat Wire Welded Coil	4M	HK27APBFN

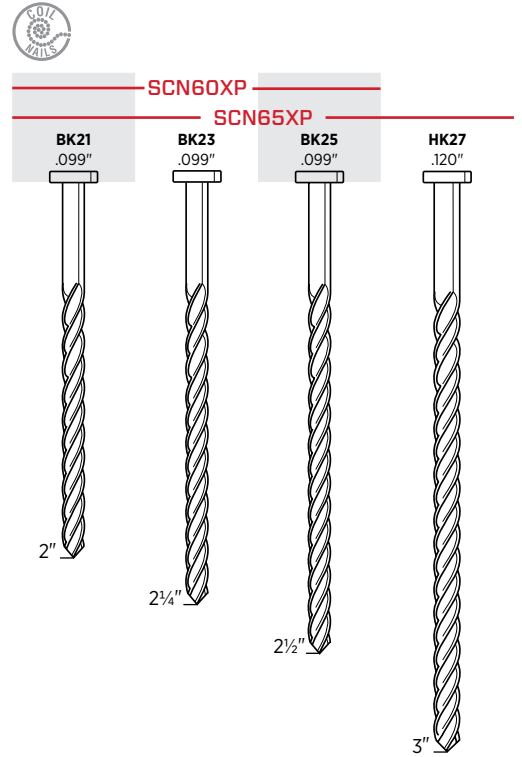

15°
COIL

Smooth Shank Stiff-Stock Coil Nails

For fastening wood to masonry

Length	Point	Finish	Coating	Collation	Box Count	Item Code
1½" x .099"	Diamond	Bright	Sencote	15° Flat Wire Welded Coil	3M	M003011

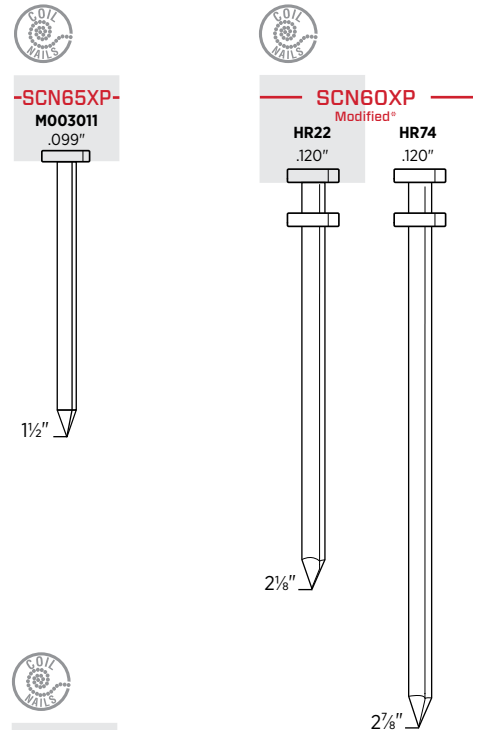

15°
COIL

Duplex Smooth Shank Coil Nails*

Framing, trusses, crating and concrete forms

Length	Point	Finish	Coating	Collation	Box Count	Item Code
2½" x .120"	Diamond	Bright	Plain	15° Flat Wire Welded Coil	5.4M	HR22APAF
2¾" x .120"	Diamond	Bright	Plain	15° Flat Wire Welded Coil	3.6M	HR74APAF

*Requires a special-order modified SCN60XP tool (order XA1739)

15°
COIL

Drywall Ring Shank Bugle Head Coil Nails

For fastening drywall to wood

Length	Point	Finish	Coating	Collation	Box Count	Item Code
1½" x .099"	Diamond	Galv	Plain	15° Conical Wire Welded Coil	6.4M	BG17AAAQ
1¾" x .099"	Diamond	Galv	Plain	15° Conical Wire Welded Coil	6.4M	BG18AAAQ

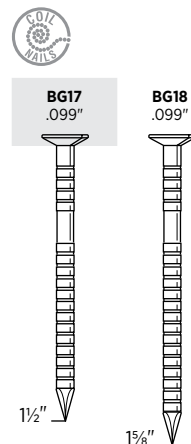

FRAMING, SHEATHING & SUBFLOOR FASTENERS



Collated Concrete and Steel Pins

For fastening drywall track, wood furring, hat channels, metal washers or ceiling grid to concrete, concrete block and steel

Length	Point	Finish	Coating	Collation	Box Count	Item Code
1/2" x .109"/.118"	Pinched	Zinc Plated	Plain	Straight Plastic Collated Strip	1M	W3050YXS
3/4" x .109"	Pinched	Zinc Plated	Plain	Straight Plastic Collated Strip	1M	W3075YXC
1" x .109"	Pinched	Zinc Plated	Plain	Straight Plastic Collated Strip	1M	W3100YXC
1 1/4" x .109"	Pinched	Zinc Plated	Plain	Straight Plastic Collated Strip	1M	W3125YXC
1 1/2" x .109"	Pinched	Zinc Plated	Plain	Straight Plastic Collated Strip	1M	W3150YXC

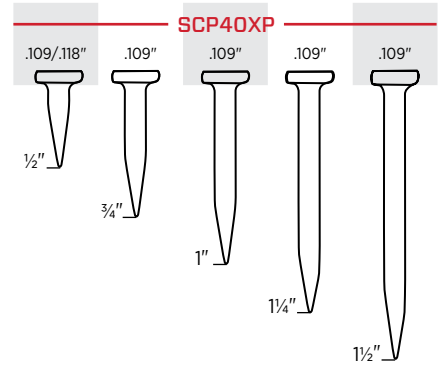

Hardened Metal Connector Nails

Joist hangers, foundation anchors, seismic and hurricane straps and ties

Length	Point	Finish	Coating	Collation	Box Count	Item Code
1 1/2" x .148"	Diamond	Bright	Plain	34° Paper Tape Strip	3M	MD17AQBD
2 1/2" x .148"	Diamond	Bright	Plain	34° Paper Tape Strip	2.5M	MD25AQBDN
2 1/2" x .162"	Diamond	Bright	Plain	34° Paper Tape Strip	2M	ND25AQBDN
1 1/2" x .148"	Diamond	Hot Dip	Plain	34° Paper Tape Strip	3M	MD17AJBDN
2 1/2" x .148"	Diamond	Hot Dip	Plain	34° Paper Tape Strip	2.5M	MD25AJBDN
2 1/2" x .162"	Diamond	Hot Dip	Plain	34° Paper Tape Strip	2M	ND25AJBDN

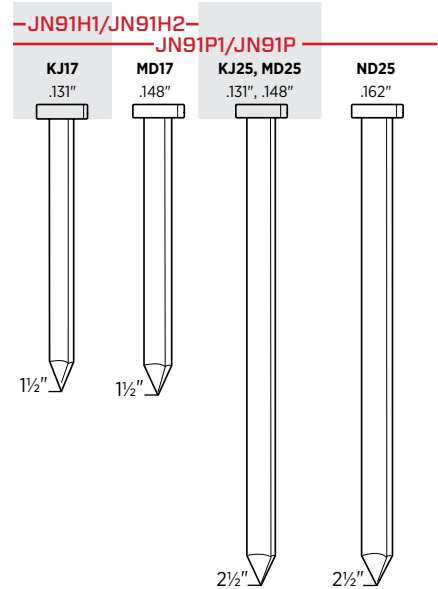

Heat Treated Metal Connector Nails

Joist hangers, foundation anchors, seismic and hurricane straps and ties

Length	Point	Finish	Coating	Collation	Box Count	Item Code
1 1/2" x .131"	Diamond	Bright	Plain	34° Paper Tape Strip	2M	KJ17AHBD
2 1/2" x .148"	Diamond	Bright	Plain	34° Paper Tape Strip	1.5M	MD25AHBD
1 1/2" x .131"	Diamond	Hot Dip	Plain	34° Paper Tape Strip	2M	KJ17AEBD



Non-Heat Treated Metal Connector Nails

Standard tensile, non-hardened nails for use in joist hangers, foundation anchors, seismic and hurricane straps and ties

Length	Point	Finish	Coating	Collation	Box Count	Item Code
1 1/2" x .131"	Diamond	Bright	Plain	34° Paper Tape Strip	2M	M002261
1 1/2" x .148"	Diamond	Bright	Plain	34° Paper Tape Strip	2M	M002263
2 1/2" x .148"	Diamond	Bright	Plain	34° Paper Tape Strip	1.5M	M002265
1 1/2" x .131"	Diamond	Hot Dip	Plain	34° Paper Tape Strip	2M	M002262
1 1/2" x .148"	Diamond	Hot Dip	Plain	34° Paper Tape Strip	2M	M002264
2 1/2" x .148"	Diamond	Hot Dip	Plain	34° Paper Tape Strip	1.5M	M002266

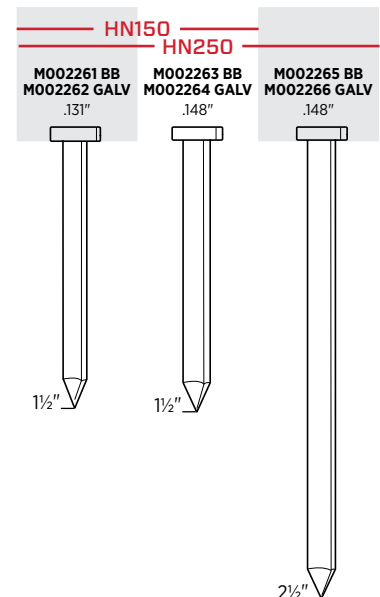

FRAMING, SHEATHING & SUBFLOOR FASTENERS

16
GA
P

1" Crown Heavy Wire Staples

Sheathing, house wrap, composite roofing, roofing felt, corrugated containers, foam insulation board, furniture/cabinet frames and butt joints

Length	Point	Finish	Coating	Collation	Box Count	Item Code
3/8"	Chisel	Galv	Plain	Glued	10M	P06BAA*
1/2"	Chisel	Galv	Sencote	Taped	10M	P08BABT*
5/8"	Chisel	Galv	Sencote	Taped	10M	P10BAB*
5/8"	Divergent	Galv	Sencote	Glued	10M	P10FAB*
5/8"	Chisel	Galv	Coated	Glued	10M	P10BPE*
3/4"	Chisel	Galv	Sencote	Taped	10M	P11BAB
3/4"	Chisel	Galv	Coated	Glued	10M	P11BPE
7/8"	Chisel	Galv	Sencote	Taped	10M	P12BAB
1"	Chisel	Galv	Sencote	Taped	10M	P13BAB
1"	Chisel	Galv	Sencote	Glued	10M	P13BPE
1 1/4"	Chisel	Galv	Sencote	Taped	10M	P15BAB
1 1/4"	Chisel	Galv	Coated	Glued	10M	P15BPE
1 1/2"	Chisel	Galv	Sencote	Taped	10M	P17BAB
1 3/4"	Chisel	Galv	Sencote	Taped	5M	P19BAB
2"	Chisel	Galv	Sencote	Taped	5M	P21BAB
1"	Outside Chisel	Stainless 304	Sencote	Taped	5M	P13BGBN
1"	Chisel	Galv	Plain	Glued	1M	P13BABR
1 1/4"	Chisel	Galv	Plain	Glued	1M	P15BABR

*Use kit #YK0883 with PS15XP for 3/8"-5/8" staples

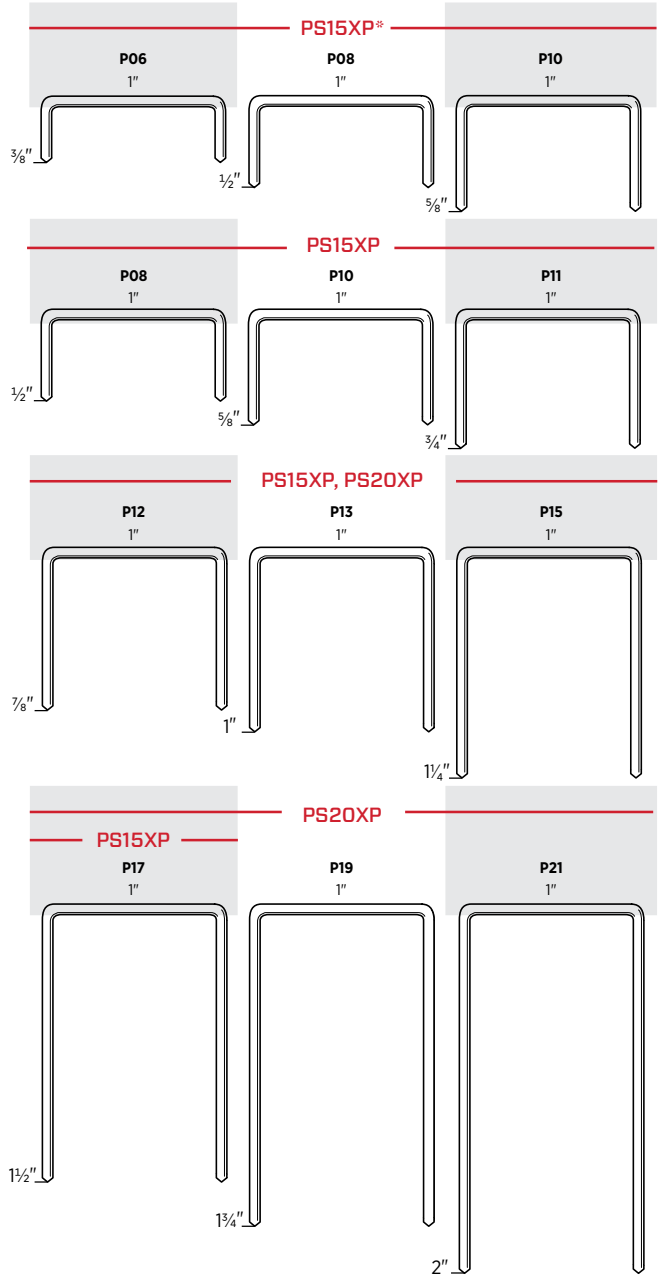

FRAMING, SHEATHING & SUBFLOOR FASTENERS

16_{DA}
N

1/16" Crown Heavy Wire Staples

Sheathing, soffits, underlayment, lattice, cabinets, casebacks and drawers

Length	Point	Finish	Coating	Collation	Box Count	Item Code
3/4"	Chisel	Bright	Sencote	Glued	5M	N11BRB
1"	Chisel	Bright	Sencote	Glued	5M	N13BRB
1 1/8"	Chisel	Bright	Sencote	Taped	10M	N14BRB
1 1/4"	Chisel	Bright	Sencote	Taped	10M	N15BRB
1 3/8"	Chisel	Bright	Sencote	Taped	10M	N16BRB
1 1/2"	Chisel	Bright	Sencote	Taped	10M	N17BRB
1 5/8"	Chisel	Bright	Sencote	Taped	10M	N18BRB
1 3/4"	Chisel	Bright	Sencote	Taped	10M	N19BRB
2"	Chisel	Bright	Sencote	Taped	10M	N21BRB
1/2"	Chisel	Galv	Sencote	Glued	5M	N08BABN
1/2"	Chisel	Galv*	Sencote	Glued	5M	N08BBBN
1/2"	Diverg	Galv*	Sencote	Glued	5M	N08FBB
5/8"	Chisel	Galv*	Sencote	Glued	5M	N10BAB
3/4"	Chisel	Galv	Sencote	Glued	5M	N11BAB
3/4"	Diverg	Galv*	Sencote	Glued	5M	N11FBB
7/8"	Chisel	Galv	Sencote	Glued	5M	N12BABN
7/8"	Diverg	Galv	Sencote	Glued	5M	N12FABN
1"	Chisel	Galv	Sencote	Glued	5M	N13BAB
1"	Diverg	Galv	Sencote	Glued	5M	N13FAB
1 1/8"	Chisel	Galv	Sencote	Taped	10M	N14BAB
1 1/4"	Chisel	Galv	Sencote	Taped	10M	N15BAB
1 1/4"	Diverg	Galv	Sencote	Glued	10M	N15FAB
1 3/8"	Chisel	Galv	Sencote	Taped	10M	N16BAB
1 1/2"	Chisel	Galv	Sencote	Taped	10M	N17BAB
1 5/8"	Chisel	Galv	Sencote	Taped	10M	N18BAB
1 3/4"	Chisel	Galv	Sencote	Taped	10M	N19BAB
2"	Chisel	Galv	Sencote	Taped	10M	N21BAB
1 1/4"	Chisel	Stainless 304	Sencote	Glued	3M	N15BGB
1 1/2"	Chisel	Stainless 304	Sencote	Glued	3M	N17BGB
1 3/4"	Chisel	Stainless 304	Sencote	Glued	3M	N19BGBN
2"	Chisel	Stainless 304	Sencote	Glued	3M	N21BGBN

*Galvanized High-Tensile Steel

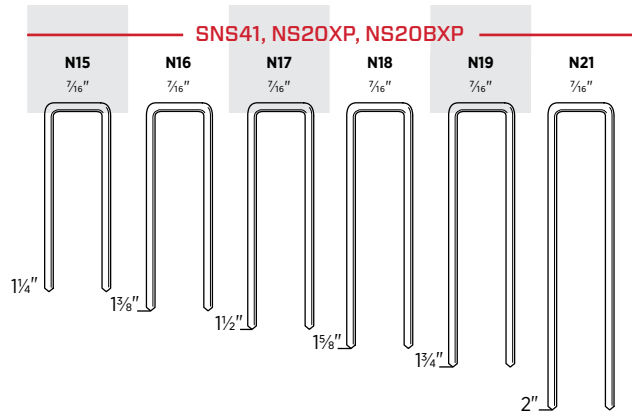
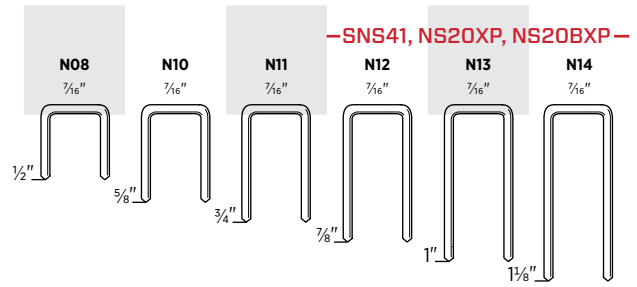

15_{DA}
Q

1/16" Crown Heavy Wire Staples

Framing, sheathing, subflooring, decking, lathing, door and window units, fencing, pallets, crate and box assembly, furring and furniture framing

Length	Point	Finish	Coating	Collation	Box Count	Item Code
1 1/2"	Chisel	Bright	Sencote	Taped	5M	Q17BRB
1 3/4"	Chisel	Bright	Sencote	Taped	5M	Q19BRB
2"	Chisel	Bright	Sencote	Taped	5M	Q21BRB
2 1/4"	Chisel	Bright	Sencote	Taped	5M	Q23BRB
2 1/2"	Chisel	Bright	Sencote	Taped	5M	Q25BRB
1 1/4"	Chisel	Galv	Sencote	Taped	5M	Q15BAB
1 1/2"	Chisel	Galv	Sencote	Taped	5M	Q17BAB
1 3/4"	Chisel	Galv	Sencote	Taped	5M	Q19BAB
2"	Chisel	Galv	Sencote	Taped	5M	Q21BAB
2 1/2"	Chisel	Galv	Sencote	Taped	5M	Q25BAB
1 3/4"	Chisel	Stainless 304	Sencote	Taped	2.2M	Q19BGBN
2 1/2"	Chisel	Stainless 304	Sencote	Taped	1M	Q25BGBN

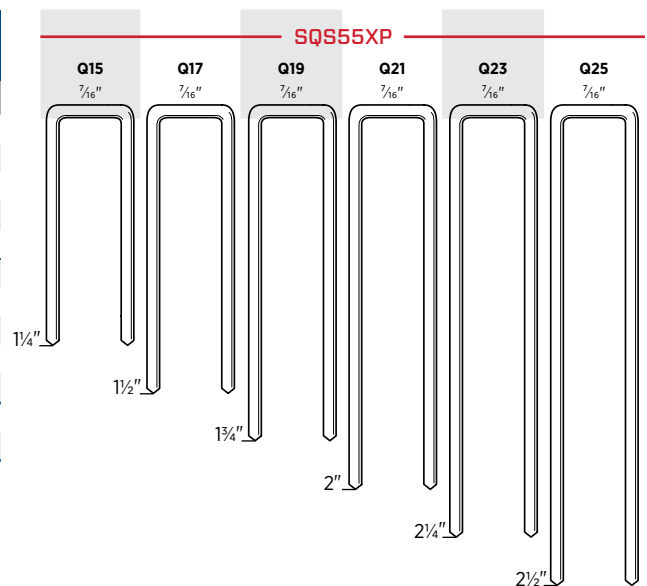

ROOFING, SIDING & FENCING

WE COVER IT ALL

When it comes to roofing applications or installing siding, uptime is everything. SENCO has designed a full line of tools and fasteners to maximize your productivity.

Our RoofPro™445XP with its innovative firing valve uses 5% less air. A bi-metal driver blade increases durability. And our power in, power out feed system is air driven for stability and speed.

APPLICATIONS

SENCO offers a variety of coil nailers and crown staplers with fasteners optimized for different types of shingles, siding, sheathing, and felt underlayment.

KEY FEATURES

- High-strength housings
- Long-lasting wear plates
- Easy, one-handed operation
- Adjustable depth-of-drive



RoofPro™445XP

1¾" COIL ROOFING NAILER

ITEM #8V0001N



Features

- Innovative firing valve reduces air consumption without compromising power or speed
- Bi-metal driver blade reduces wear and improves durability
- Power in, power out feed system improves speed and delivers consistent drives
- Metal wear plate in nail canister reduces wear and helps improve nail feed
- Adjustable and removable shingle guide

SN71P1

2½" COIL NAILER



Features

- Dual collation – allows the choice between wire or plastic collation
- Tool-free depth of drive
- High load capacity (up to 375 nails)
- Overmold grip
- Rotatable rafter hook
- EZ-Load design



It doesn't cost a bundle to drive the very best.



— Building Code Approved

— Professional Performance

Product Reference Chart

TOOL SPECS	RoofPro™445XP	SN71P1
Trigger	Contact	Selectable
Operating Pressure	70-120 psi (4.8-8.3 bar)	70-120 psi (4.8-8.3 bar)
Air Consumption (60 CPM)	3.86 scfm	4.6 scfm
Air Inlet	¼" NPT	⅜" NPT
Weight	5.2 lbs (2.35 kg)	5.58 lbs (2.53 kg)
Height	10.9" (276 mm)	12.75" (324 mm)
Length	10.6" (269 mm)	11.63" (295 mm)
Width	4.5" (114 mm)	5.06" (129 mm)
Main Body Material	Aluminum	Magnesium
Warranty	5 yrs	5 yrs
FASTENER SPECS	Fasteners are located on pages 51-52	
Range	¾"-1¼"	1¼"-2½"
Shank	.120"	.082"-.092"
Capacity	120	250-375
Angle/Collation	15° Flat Wire Welded Coil	15° Flat Wire Welded or Plastic Carrier Coil
Series	HJ, M00	ED, EJ, EL, SE
TOOL FEATURES		
Depth-of-Drive	Yes, Tool-Free	Yes, Tool-Free
Tool-Free Jam Clearing	Yes	Yes
Adjustable Exhaust	No	Yes

PS15RXP

1" CROWN 1½" ROOFING STAPLER

ITEM #9U0001N

16^{GA}
P



Features

- Enhanced quick clear latch allows for quick access to clear fasteners
- New aggressive locking feature offers pinpoint accuracy and unrivaled driveability
- Updated drive track eliminates staple movement, virtually eliminating jams
- Positive-locking adjustable depth-of-drive ensures consistently flush drives
- Hardened wear plates and safety protect tool from shingle damage

BC58

½" CROWN ⅝" STAPLE + 1" CAP

ITEM #4A0001N

CAP
STAPLE



Features

- EZ-Load system for staples and caps
- Ultra-lightweight for ease of use and maneuverability
- Balanced and fast for greater productivity
- Side-mounted cap collator holds caps regardless of tool position

A11

⅞" CROWN ⅜" HAMMER STAPLER

ITEM #PC0700

20^{GA}
H



Features

- Rugged all-steel construction
- Easy to service and maintain
- Comfortable fluted handle with grip

Product Reference Chart

TOOL SPECS	PS15RXP	BC58	A11
Trigger	Contact	Contact	—
Operating Pressure	70–120 psi (4.8–8.3 bar)	60–95 psi (4.1–6.5 bar)	—
Air Consumption (60 CPM)	3.18 scfm	.77 scfm	—
Air Inlet	⅜" NPT	¼" NPT	—
Weight	5.5 lbs (2.5 kg)	4.1 lbs (2 kg)	2 lbs (.9 kg)
Height	9" (229 mm)	8.5" (216 mm)	1.75" (44.4 mm)
Length	15.25" (387 mm)	12.5" (317 mm)	12.3" (312.4 mm)
Width	4" (105 mm)	3.5" (89 mm)	—
Main Body Material	Aluminum	Aluminum	Steel
Warranty	5 yrs	5 yrs	1 yr
FASTENER SPECS	Fasteners are located on page 53		
Gauge	16	21	20
Crown	1"	½"	⅞"
Range	⅝"–1½"	⅝" Galv.	⅜"
Capacity	160	110	168
Angle/Collation	Taped and taped glued	Glued Staple, Laser Welded Cap	Straight Glued Strip
Series	P	M004092, Cap	H
TOOL FEATURES			
Depth-of-Drive	Yes, Tool-Free	No	—
Tool-Free Jam Clearing	Yes	No	Yes
Adjustable Exhaust	No	Yes	—

ROOFING, SIDING & FENCING FASTENERS



Smooth Shank Coil Nails

Siding, asphalt and fiberglass shingles and vapor barriers

Length	Point	Finish	Coating	Collation	Box Count	Item Code
¾" x .120"	Diamond	Galv	Plain	15° Flat Wire Welded Coil	7.2M	M003101
1" x .120"	Diamond	Galv	Plain	15° Flat Wire Welded Coil	7.2M	M003103
1¼" x .120"	Diamond	Galv	Plain	15° Flat Wire Welded Coil	7.2M	M003104
1½" x .120"	Diamond	Galv	Plain	15° Flat Wire Welded Coil	7.2M	M003105
1¾" x .120"	Diamond	Galv	Plain	15° Flat Wire Welded Coil	7.2M	M003106

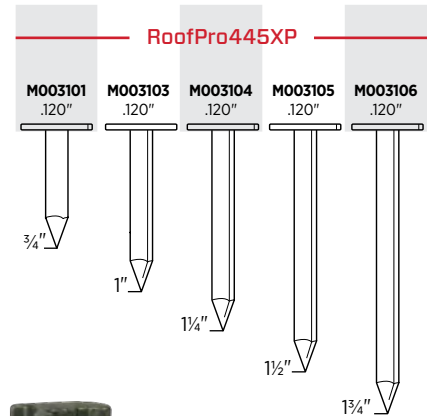

Vinyl Siding Attachment (Sold Separately)

Convert RoofPro™445XP and RoofPro™455XP into vinyl siding nailer

Fits Tool	Item Code
RoofPro™445XP	HA0308
RoofPro™455XP	MA0013



Smooth Shank Coil Nails

Siding, packaging, fencing, pallets and underlayment

Length	Point	Finish	Coating	Collation	Box Count	Item Code
1½" x .099"	Diamond	Bright	Sencote	15° Plastic Carrier Coil	6M	BD17APBC
2" x .092"	Diamond	Exterior	Sencote	15° Flat Wire Welded Coil	7.2M	EJ21ADBH
2¼" x .092"	Diamond	Galv	Sencote	15° Flat Wire Welded Coil	3.6M	ED23AABH
2¼" x .092"	Diamond	Exterior	Sencote	15° Conical Wire Welded Coil	7.2M	EJ23ADBH
2¼" x .092"	Diamond	Hot Dip	Sencote	15° Plastic Carrier Coil	3.6M	EJ23ASBC

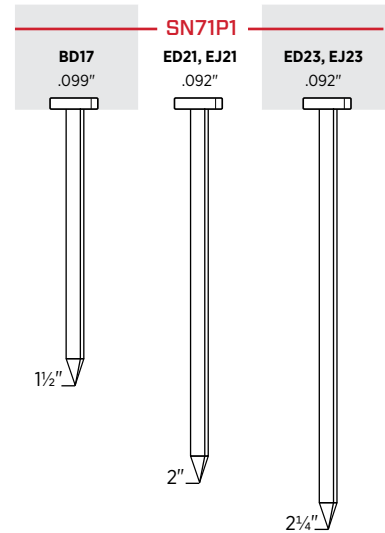

ROOFING, SIDING & FENCING FASTENERS

15°
COIL

Ring Shank Coil Nails

Siding, packaging, fencing, wood shingles, crating and pallets

Length	Point	Finish	Coating	Collation	Box Count	Item Code
1/4" x .082"	Diamond	Bright	Sencote	15° Conical Wire Welded Coil	15M	SE15APB
1/4" x .082"	Diamond	Bright	Sencote	15° Flat Wire Welded Coil	14M	SE15APBH
1/2" x .082"	Diamond	Bright	Sencote	15° Flat Wire Welded Coil	11.2M	SE17APBH
3/4" x .082"	Diamond	Bright	Sencote	15° Conical Wire Welded Coil	12M	SE19APB
1 3/4" x .092"	Diamond	Hot Dip	Sencote	15° Flat Wire Welded Coil	3.6M	EL19ASBH
1 7/8" x .092"	Diamond	Galv	Sencote	15° Flat Wire Welded Coil	3.6M	EL20AABH
1 7/8" x .092"	Diamond	Hot Dip	Sencote	15° Flat Wire Welded Coil	3.6M	EL20ASBH
2" x .092"	Diamond	Hot Dip	Sencote	15° Flat Wire Welded Coil	3.6M	EL21ASBH
2 1/4" x .092"	Diamond	Galv	Sencote	15° Flat Wire Welded Coil	3.6M	EL23AABH
2 1/4" x .092"	Diamond	Hot Dip	Sencote	15° Plastic Carrier Coil	3.6M	EL23ASBC
2 1/4" x .092"	Diamond	Hot Dip	Sencote	15° Flat Wire Welded Coil	3.6M	EL23ASBH
1 3/4" x .092"	Diamond	Stainless 304	Sencote	15° Flat Wire Welded Coil	3.6M	EL19AGBH
2" x .092"	Diamond	Stainless 304	Sencote	15° Flat Wire Welded Coil	3.6M	EL21AGBH
2 1/4" x .092"	Diamond	Stainless 304	Sencote	15° Flat Wire Welded Coil	3.6M	EL23AGBH

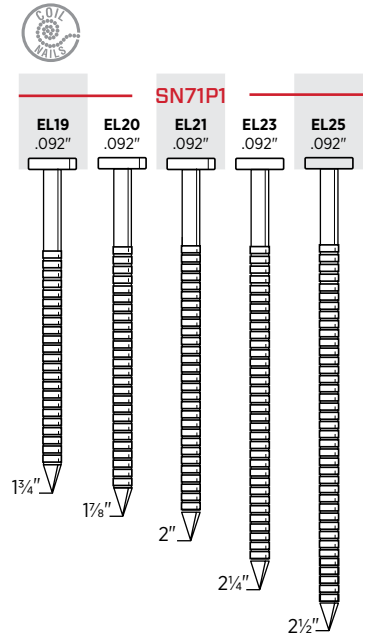
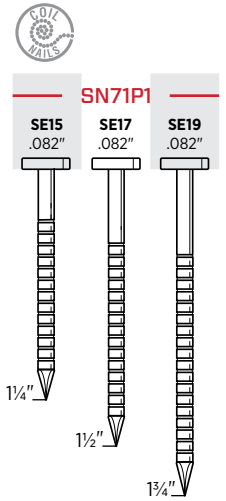

ROOFING, SIDING & FENCING FASTENERS

16^{GA}
P

1" Crown Heavy Wire Staples

Composite roofing, roofing felt, foam insulation board, house wrap, sheathing, corrugated containers, furniture/cabinets and butt joints

Length	Point	Finish	Coating	Collation	Box Count	Item Code
3/8"	Chisel	Galv	Plain	Glued	10M	P06BAA*
1/2"	Chisel	Galv	Sencote	Taped	10M	P08BAPT*
5/8"	Chisel	Galv	Sencote	Taped	10M	P10BAB*
5/8"	Divergent	Galv	Sencote	Glued	10M	P10FAB*
5/8"	Chisel	Galv	Coated	Glued	10M	P10BPE*
3/4"	Chisel	Galv	Sencote	Taped	10M	P11BAB
3/4"	Chisel	Galv	Coated	Glued	10M	P11BPE
7/8"	Chisel	Galv	Sencote	Taped	10M	P12BAB
1"	Chisel	Galv	Sencote	Taped	10M	P13BAB
1"	Chisel	Galv	Sencote	Glued	10M	P13BPE
1 1/4"	Chisel	Galv	Sencote	Taped	10M	P15BAB
1 1/4"	Chisel	Galv	Coated	Glued	10M	P15BPE
1 1/2"	Chisel	Galv	Sencote	Taped	10M	P17BAB
1"	Outside Chisel	Stainless 304	Sencote	Taped	5M	P13BGBN

*Use kit #YK0883 with PS15RXP for 3/8"-5/8" staples

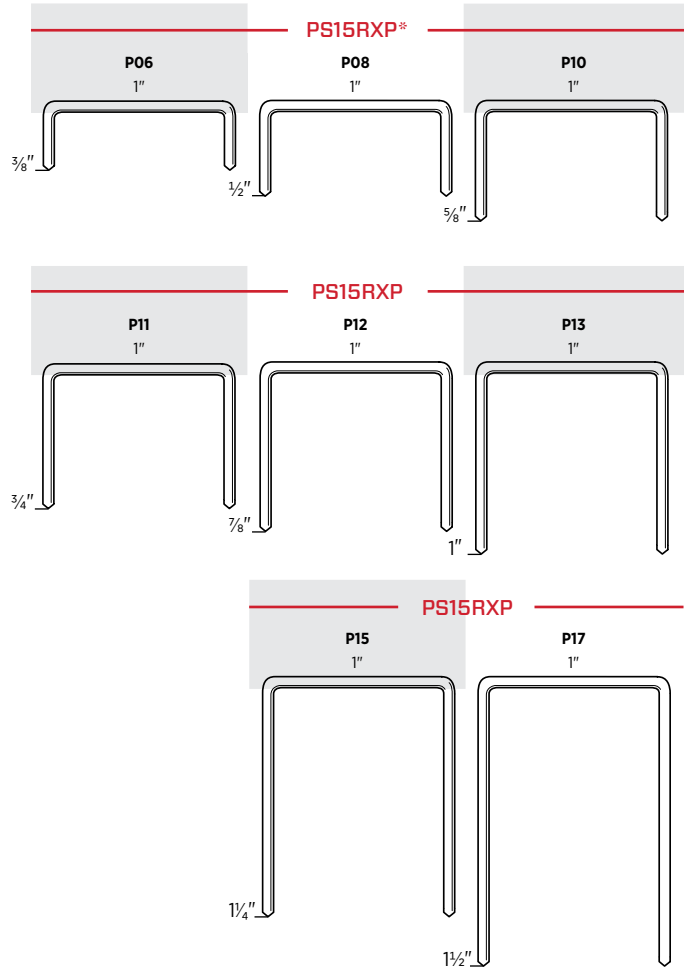

20^{GA}
H

7/16" Crown Fine Wire Staples

Roofing, insulation and vapor barriers

Length	Point	Finish	Coating	Collation	Box Count	Item Code
3/8"	Chisel	Galv	Plain	Glued	5M	H06BAA

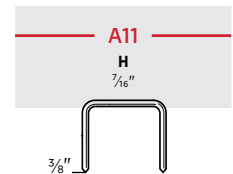

CAP
STAPLE

1" Cap & 1/2" Crown Staples

Roof felt installation and house wrap

Length	Point	Finish	Coating	Collation	Box Count	Item Code
5/8"	Chisel	Galv	Plain	Glued	2.2M	M004092
1"	—	Plastic	—	Laser Weld	2.2M	—

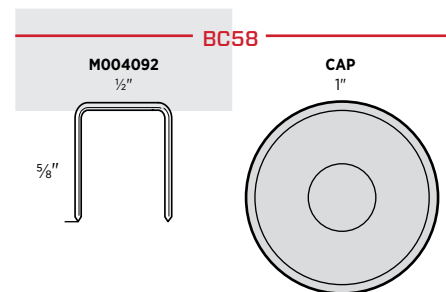

PALLETS & CRATING

THE DURABILITY TO DRIVE ALL DAY

SENCO's PalletPro™ heavy-duty coil nailers are built specifically for the challenges of pallets and crating. The PalletPro130 can drive fasteners as long as 5½" and hold up to 225 nails.

APPLICATIONS

Pallets, crates, heavy-duty framing and truss attachment

KEY FEATURES

- Durable drivers and bumpers
- Flexible collation deflectors
- Dust guards for safe operation and extended use

Clinch and sisal anvil staple tools come in 18 and 20 gauge ½" and ⅞" crowns. Great for hand-held or mounted applications.

APPLICATIONS

Packaging, corrugated box fabrication, shoe making and bedding: basically any time two materials must be stapled and clinched together

FEATURES

- High-capacity magazines
- Extended reach capability
- Tool-free adjustable anvil opening
- Bottom-load magazines



PalletPro™57FXP

2¼" COIL NAILER

ITEM #4L0001N

15°
COIL



Features

- High load capacity
- Ultra-durability driver and piston bumper for long life
- Adjustable nail canister accommodates wide range of nails
- Body protection — side steel wear plates reduce abrasion of tool

PalletPro™100XP

4" COIL NAILER (SPECIAL ORDER TOOL)

ITEM #5L0001N

15°
COIL



Features

- High load capacity
- Includes optional heavy-duty threaded T-handle
- Flexible collation deflector and dust guard for improved safety in commercial environments
- Strengthened driver and bumper for extended use and reliable service

PalletPro™130XP

5½" COIL NAILER (SPECIAL ORDER TOOL)

ITEM #5M0001N

15°
COIL



Features

- High load capacity
- Includes optional heavy-duty threaded T-handle
- Flexible collation deflector and dust guard for improved safety in commercial environments
- Strengthened driver and bumper for extended use and reliable service

Product Reference Chart

TOOL SPECS	PalletPro™57FXP	PalletPro™100XP	PalletPro™130XP
Trigger	Contact	Contact	Sequential
Operating Pressure	70-120 psi (4.9-8.4 bar)	70-120 psi (4.9-8.4 bar)	70-120 psi (4.9-8.4 bar)
Air Consumption (60 CPM)	3.07 scfm	11.4 scfm	11.4 scfm
Air Inlet	¾" NPT	¾" NPT	¾" NPT
Weight	5.9 lbs (2.67 kg)	11.5 lbs (5.24 kg)	13 lbs (5.9 kg)
Height	11.25" (286 mm)	16.5" (418 mm)	18" (457 mm)
Length	11.88" (302 mm)	13.25" (338 mm)	13" (330 mm)
Width	5.25" (123 mm)	6" (153 mm)	6.6" (168 mm)
Main Body Material	Aluminum	Aluminum	Aluminum
Warranty	5 yrs	5 yrs	5 yrs
FASTENER SPECS	Fasteners are located on pages 57-59		
Range	1"-2¼"	2¼"-4"	3"-5½"
Shank	.082"-.092"	.099"-.148"	.120"-.148"
Capacity	300-350	225-300	120-225
Angle/Collation	15° Flat Wire Welded Coil	15° Flat Wire Welded Coil	15° Flat Wire Welded Coil
Series	BK, ED, EJ, EL, SE	BE, BK, BL, BT, HK, GD, GL, HD, HL, KD	HD, HK, HL, KD, MD
TOOL FEATURES			
Tool-Free Jam Clearing	Yes	Yes	Yes
Depth-of-Drive	No	No	No
Debris Shield	Yes	Yes	Yes

DFPXP

20 Ga. 1/2" CROWN, 1/2" STAPLE
CLINCH TOOL

ITEM #8H0001N

20
GA
F



Features

- High-capacity magazine — less reloading means greater productivity
- Tool-free adjustable anvil opening
- Rubber comfort grip reduces vibration, slipping and fatigue
- Bottom-load magazine for quick reloading
- 6.9" throat allows for extended reach into cartons

F75LXP

18 Ga. 7/16" CROWN, 5/8" STAPLE
CLINCH TOOL

ITEM #8J0002N

18
GA
J



Features

- High-capacity magazine — less reloading means greater productivity
- Tool-free adjustable anvil opening
- Rubber comfort grip reduces vibration, slipping and fatigue
- Bottom-load magazine for quick reloading
- 6.9" throat allows for extended reach into cartons

F75SXP

18 Ga. 7/16" CROWN, 5/8" STAPLE
SISAL ANVIL

ITEM #8J0001N

18
GA
J



Features

- High-capacity magazine — less reloading means greater productivity
- Tool-free adjustable anvil opening
- Rubber comfort grip reduces vibration, slipping and fatigue
- Bottom-load magazine for quick reloading

Product Reference Chart

TOOL SPECS	DFPXP	F75LXP	F75SXP
Trigger	Sequential	Sequential	Sequential
Operating Pressure	65-100 psi (4-7 bar)	65-100 psi (4-7 bar)	65-100 psi (4-7 bar)
Air Consumption (60 CPM)	.7 scfm	.7 scfm	.8 scfm
Air Inlet	1/4" NPT	1/4" NPT	1/4" NPT
Weight	4.9 lbs (2.24 kg)	4.9 lbs (2.24 kg)	4.9 lbs (2.24 kg)
Height	12.9" (327 mm)	12.9" (327 mm)	12.9" (327 mm)
Length	14.9" (380 mm)	14.9" (380 mm)	14.9" (380 mm)
Width	3" (75 mm)	3" (75 mm)	3" (75 mm)
Main Body Material	Aluminum	Aluminum	Aluminum
Warranty	5 yrs	5 yrs	5 yrs
FASTENER SPECS	Fasteners are located on page 59		
Gauge	20	18	18
Crown	1/2"	7/16"	7/16"
Range	5/16"-5/8"	5/16"-5/8"	5/16"-5/8"
Capacity	230	152	152
Angle/Collation	Straight Glued Strip	Straight Glued Strip	Straight Glued Strip
Series	F	J	J
TOOL FEATURES			
Tool-Free Adjustable Anvil Opening	Yes	Yes	Yes
Bottom-Load Magazine	Yes	Yes	Yes
Extended Reach Capability	Yes	Yes	No

PALLETS & CRATING FASTENERS

15°
COIL

Smooth Shank Coil Nails

Pallets, crates, fencing, siding and underlayment

Length	Point	Finish	Coating	Collation	Box Count	Item Code
2" x .092"	Diamond	Exterior	Sencote	15° Flat Wire Welded Coil	7.2M	EJ21ADBH
2¼" x .092"	Diamond	Galv	Sencote	15° Flat Wire Welded Coil	3.6M	ED23AABH

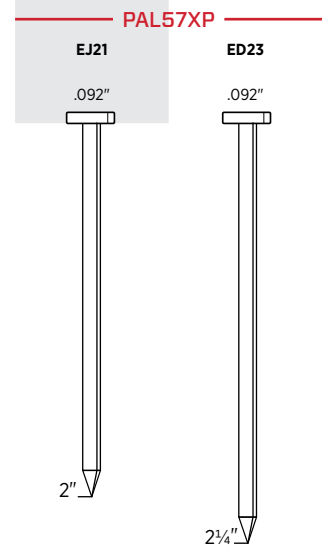

15°
COIL

Smooth Shank Coil Nails

Pallets, framing, sheathing, subfloor, decks and trusses

Length	Point	Finish	Coating	Collation	Box Count	Item Code
2" x .113"	Diamond	Bright	Sencote	15° Flat Wire Welded Coil	6M	GD21APBF
2½" x .113"	Diamond	Bright	Sencote	15° Flat Wire Welded Coil	6M	GD25APBF
2½" x .131"	Diamond	Bright	Sencote	15° Flat Wire Welded Coil	3.6M	KD25APBF
3" x .120"	Diamond	Bright	Sencote	15° Flat Wire Welded Coil	4M	HD27APBF
3" x .131"	Diamond	Bright	Sencote	15° Flat Wire Welded Coil	3.6M	KD27APBF
3¼" x .131"	Diamond	Bright	Sencote	15° Flat Wire Welded Coil	3.6M	KD28APBF
3½" x .131"	Diamond	Bright	Sencote	15° Flat Wire Welded Coil	3.6M	KD29APBF
5" x .148"	Diamond	Bright	Sencote	15° Flat Wire Welded Coil	1.8M	MD34APBF
2" x .113"	Diamond	Galv	Sencote	15° Flat Wire Welded Coil	6M	GD21AABF
2½" x .113"	Diamond	Galv	Sencote	15° Flat Wire Welded Coil	6M	GD25AABF
3" x .131"	Diamond	Hot Dip	Sencote	15° Flat Wire Welded Coil	2.4M	KD27ASBF
3¼" x .131"	Diamond	Hot Dip	Sencote	15° Flat Wire Welded Coil	2.4M	KD28ASBF

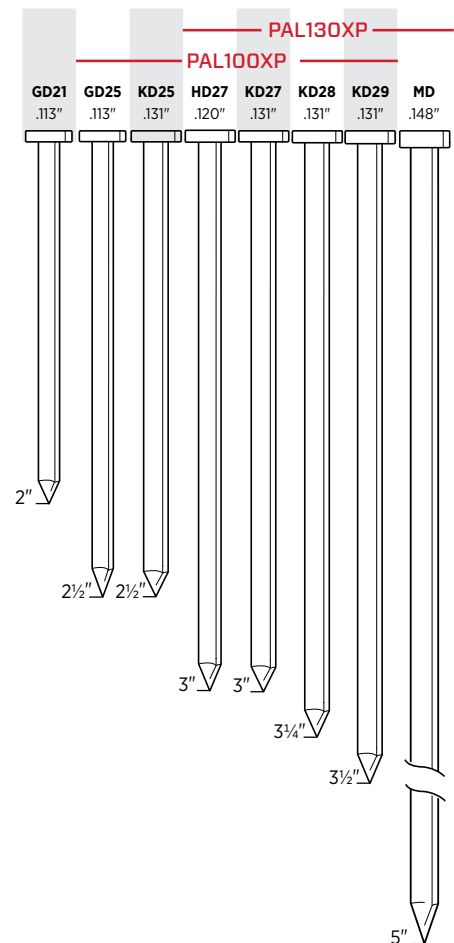

15°
COIL

Ring Shank Coil Nails

Pallets, crates, fencing, wood shingles, siding and underlayment

Length	Point	Finish	Coating	Collation	Box Count	Item Code
1¼" x .082"	Diamond	Bright	Sencote	15° Flat Wire Welded Coil	14M	SE15APBH
1½" x .082"	Diamond	Bright	Sencote	15° Flat Wire Welded Coil	11.2M	SE17APBH
1¾" x .092"	Diamond	Hot Dip	Sencote	15° Flat Wire Welded Coil	3.6M	EL19ASBH
1⅞" x .092"	Diamond	Galv	Sencote	15° Flat Wire Welded Coil	3.6M	EL20AABH
1⅞" x .092"	Diamond	Hot Dip	Sencote	15° Flat Wire Welded Coil	3.6M	EL20ASBH
2" x .092"	Diamond	Hot Dip	Sencote	15° Flat Wire Welded Coil	3.6M	EL21ASBH
2¼" x .092"	Diamond	Galv	Sencote	15° Flat Wire Welded Coil	3.6M	EL23AABH
2¼" x .092"	Diamond	Hot Dip	Sencote	15° Flat Wire Welded Coil	3.6M	EL23ASBH
1¾" x .092"	Diamond	Stainless 304	Sencote	15° Flat Wire Welded Coil	3.6M	EL19AGBH
2" x .092"	Diamond	Stainless 304	Sencote	15° Flat Wire Welded Coil	3.6M	EL21AGBH
2¼" x .092"	Diamond	Stainless 304	Sencote	15° Flat Wire Welded Coil	3.6M	EL23AGBH

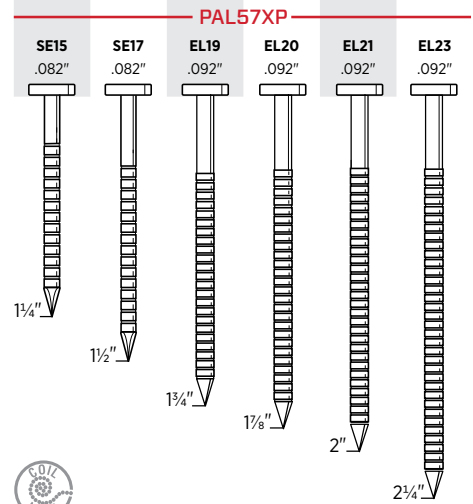

15°
COIL

Ring Shank Coil Nails

Pallets, framing, sheathing, subfloor, decks and trusses

Length	Point	Finish	Coating	Collation	Box Count	Item Code
2" x .099"	Diamond	Bright	Sencote	15° Flat Wire Welded Coil	6.6M	BL21APBF
2" x .113"	Diamond	Bright	Sencote	15° Flat Wire Welded Coil	6M	GL21APBF
2⅜" x .113"	Diamond	Bright	Sencote	15° Flat Wire Welded Coil	6M	GL24APBF
2¼" x .099"	Diamond	Galv	Sencote	15° Flat Wire Welded Coil	6.6M	BE23AABF
2⅜" x .113"	Diamond	Hot Dip	Sencote	15° Flat Wire Welded Coil	2.7M	GL24ASBF
3" x .120"	Diamond	Hot Dip	Sencote	15° Flat Wire Welded Coil	2.4M	HL27ASBF
2⅜" x .113"	Diamond	Stainless 304	Sencote	15° Flat Wire Welded Coil	2.7M	GL24AGBF

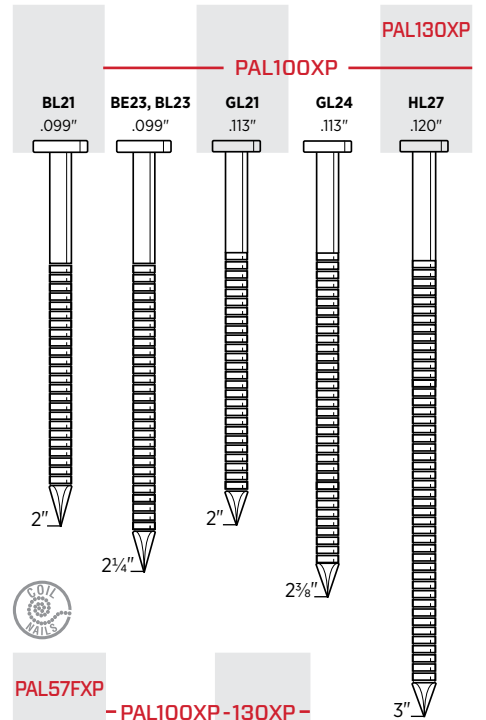

15°
COIL

Step Ring Shank Nails

Superior fastening in subfloor applications

Length	Point	Finish	Coating	Collation	Box Count	Item Code
2" x .099"	Diamond	Bright Basic	Sencote	15° Flat Wire Welded Coil	6.6M	BT21APBF
2⅜" x .113"	Diamond	Bright Basic	Sencote	15° Flat Wire Welded Coil	4M	GT24APBF
2½" x .131"	Diamond	Bright Basic	Sencote	15° Flat Wire Welded Coil	4M	KT25APBF

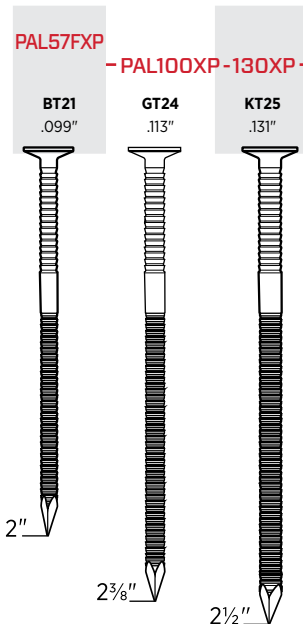

Step Ring Pallet Coil Nails

- Superior fastening in pallet applications
- Tested and proven to reduce raised nail heads
- Unique double rings shank design reduces the potential of nail backing out

PALLETS & CRATING FASTENERS

15°
COIL

Screw Shank Coil Nails

Pallets, framing, sheathing, subfloor, decks and trusses

Length	Point	Finish	Coating	Collation	Box Count	Item Code
2" x .099"	Blunt Dia.	Bright	Sencote	15° Flat Wire Welded Coil	9M	BK21BPBFN
2¼" x .099"	Blunt Dia.	Bright	Sencote	15° Flat Wire Welded Coil	9M	BK23BPBFN
2½" x .099"	Blunt Dia.	Bright	Sencote	15° Flat Wire Welded Coil	6M	BK25BPBFN
3" x .120"	Diamond	Bright	Sencote	15° Flat Wire Welded Coil	4M	HK27APBFN



PAL57FXP

BK21
.099"



2"

BK23
.099"



2¼"

PAL100XP

BK25
.099"



2½"

PAL130XP

HK27
.120"



3"

20^{BA}
F

½" Crown Fine Wire Staples

Packaging, set-up boxes and bedding

Length	Point	Finish	Coating	Collation	Box Count	Item Code
¾"	Chisel	Galv	Sencote	Glued Strip	24M	F05BAAP
¾"	Chisel	Galv	Sencote	Glued Strip	10M	F06BAA
¾"	Chisel	Galv	Sencote	Glued Strip	24M	F06BAAP
½"	Chisel	Galv	Sencote	Glued Strip	10M	F08BAAN
½"	Chisel	Galv	Sencote	Glued Strip	15M	F08BAAP
¾"	Chisel	Stainless 304	Sencote	Glued Strip	10M	F06BGA

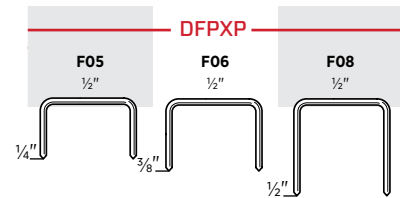

18^{BA}
J

⅞" Crown Fine Wire Staples

For assembling packaging and joining corrugated materials

Length	Point	Finish	Coating	Collation	Box Count	Item Code
¾"	Chisel	Galv	Plain	Glued Strip	5M	J06BAA
½"	Chisel	Galv	Plain	Glued Strip	5M	J08BAAN
⅝"	Chisel	Galv	Plain	Glued Strip	5M	J10BAAN

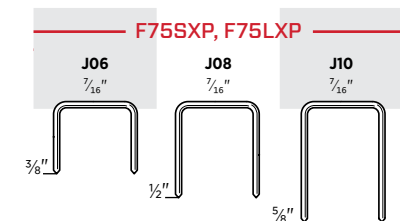

SENCO HAS YOU COVERED

SENCO offers a range of fine and medium wire staplers for upholstery and furniture assembly. Our upholstery staplers are the most customizable in the industry, with long nosepieces, extended magazines and a wide range of fasteners for any project.

APPLICATIONS

Upholstery, furniture assembly, cabinets, bedding, picture frames, molding, roof felt, house wrap, RV construction

KEY FEATURES

- Lightweight
- Ergonomic
- Variety of configurations



SFT10XP FAMILY

3/16", 3/8", 7/16", 1/2" CROWN,
5/8" FINE WIRE STAPLERS

SFT10XP



Features

- Heavy-duty steel cap
- Short trigger stroke
- Rear exhaust keeps oil off fabric
- Automatic models have adjustable speed triggers

Models and Item Codes

Crown	Ga	Staple	Description	Item Code
3/16"	22	A/D Wire	Standard	6S0001N
3/16"	22	A/D Wire	Auto	6S0101N
1/2"	22	B Wire	Standard	6S0011N
3/8"	22	C Wire	Standard	6S0021N
3/8"	22	C Wire	Auto	6S0121N
3/16"	20	E Wire	Standard	6S0031N
1/2"	20	F Wire	Standard	6S0041N
3/8"	20	G Wire	Standard	6S0051N

SFT10XP FAMILY

3/16", 3/8", 7/16", 1/2" CROWN,
5/8" FINE WIRE STAPLERS

DOUBLE LENGTH MAGAZINE



Features

- Heavy-duty steel cap
- Short trigger stroke
- Rear exhaust keeps oil off fabric
- Automatic models have adjustable speed triggers

Models and Item Codes

Crown	Ga	Staple	Description	Item Code
1/2"	22	B Wire	Standard	6S0211N
1/2"	22	B Wire	Auto	6S0311N
3/8"	22	C Wire	Standard	6S0221N
3/8"	22	C Wire	Auto	6S0321N
1/2"	20	F Wire	Auto	6S0341N
3/8"	20	G Wire	Standard	6S0251N
7/16"	20	H Wire	Auto	6S0361N

SFT10XP FAMILY

3/16", 3/8", 7/16", 1/2" CROWN,
5/8" FINE WIRE STAPLERS

LONG NOSE



Features

- Heavy-duty steel cap
- Short trigger stroke
- Rear exhaust keeps oil off fabric
- Automatic models have adjustable speed triggers

Models and Item Codes

Crown	Ga	Staple	Description	Item Code
3/16"	22	C Wire	Standard	6S0421N

Product Reference Chart

TOOL SPECS	SFT10XP
Trigger	Sequential, Auto
Operating Pressure	60-95 psi (4.1-6.5 bar)
Air Consumption (60 CPM)	.77 scfm
Air Inlet	1/4" NPT
Weight	2.1 lbs (0.955 kg)
Height	6.57" (167 mm)
Length	8.58" (218 mm)
Width	1.65" (42 mm)
Main Body Material	Aluminum
Warranty	5 yrs
FASTENER SPECS	Fasteners are located on pages 63-64
Gauge	22, 20
Crown	3/16", 3/8", 7/16", 1/2"
Range	1/4"-5/8"
Capacity	110-92
Angle/Collation	Straight Glued Strip
Series	A, B, C, D, E, F, G, H



Stapling Upholstery for Over 80 Years

SENCO® offers 18 configurations of upholstery staplers and over 40 combinations of staple length, crown and gauge.

SFW09

3/8" CROWN, 5/8" FINE WIRE STAPLER

ITEM #4C0001N

22^{GA}
C



Features

- Rear exhaust keeps oil off fabric
- Full 1" lip length
- Rear magazine bumper protects fabric
- Rounded steel cap won't snag fabric

NS20BXP

7/16" CROWN, HEAVY WIRE STAPLER

ITEM #9Y0001N

16^{GA}
N



Features

- 20% more powerful than the standard NS20XP for the most demanding applications
- Enhanced quick clear latch allows for quick access to clear fasteners
- Updated aggressive locking feature
- Drive track design eliminates movement of the staple

The NS20BXP is the Benchmark Stapler for the Furniture Industry.

- 20% more powerful than all other staplers in its class to handle even the toughest engineered woods.
- The combination of class-leading power, durability and ergonomics make it an unrivaled professional tool.



Product Reference Chart

TOOL SPECS	SFW09	NS20BXP
Trigger	Dual	Contact
Operating Pressure	60-95 psi (4.1-6.5 bar)	70-120 psi (4.8-8.3 bar)
Air Consumption (60 CPM)	.77 scfm	3.98 scfm
Air Inlet	1/4" NPT	3/8" NPT
Weight	2.1 lbs (0.955 kg)	5.8 lbs (2.6 kg)
Height	6" (152 mm)	11" (279 mm)
Length	9.25" (235 mm)	15" (381 mm)
Width	1.63" (41 mm)	4" (102 mm)
Main Body Material	Aluminum	Aluminum
Warranty	5 yrs	5 yrs
FASTENER SPECS	Fasteners are located on pages 63, 65	
Gauge	22	16
Crown	3/8"	7/16"
Range	5/32"-5/8"	1"-2"
Capacity	110-168	160
Angle/Collation	Straight Glued Strip	Straight Glued/Taped Strip
Series	C	N

UPHOLSTERY & FURNITURE FASTENERS

22^{BA}
A/D

3/16" Crown Fine Wire Staples

Furniture upholstery, felt, insulation, casebacks, screening and shoes

Length	Point	Finish	Coating	Collation	Box Count	Item Code
1/4"	Chisel	Galv	Sencote	Straight Glued Strip	10M	A04BAAN
3/8"	Chisel	Galv	Sencote	Straight Glued Strip	30M	A06BABN
3/8"	Chisel	Galv	Sencote	Straight Glued Strip	40M	A06BABP
1/2"	Chisel	Galv	Sencote	Straight Glued Strip	20M	A08BAB
1/2"	Chisel	Galv	Sencote	Straight Glued Strip	30M	A08BABP
5/8"	Chisel	Galv	Sencote	Straight Glued Strip	20M	D10BABN
5/8"	Chisel	Galv	Sencote	Straight Glued Strip	23M	D10BABPN

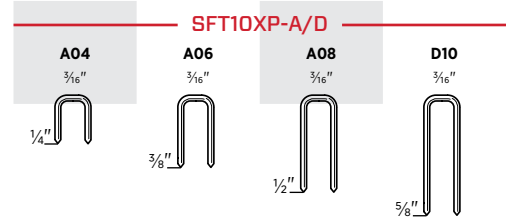

22^{BA}
B

1/2" Crown Fine Wire Staples

Furniture upholstery, felt, insulation, casebacks, screening and shoes

Length	Point	Finish	Coating	Collation	Box Count	Item Code
1/4"	Chisel	Galv	Plain	Straight Glued Strip	25M	B04BAAPN
3/8"	Chisel	Galv	Plain	Straight Glued Strip	40M	B06BAAP
1/2"	Chisel	Galv	Plain	Straight Glued Strip	25M	B08BAAP

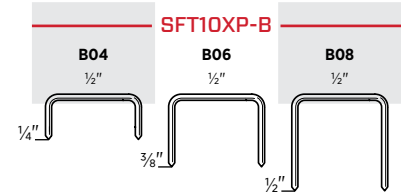

22^{BA}
C

3/8" Crown Fine Wire Staples

Furniture upholstery, felt, insulation, casebacks, screening and shoes

Length	Point	Finish	Coating	Collation	Box Count	Item Code
5/32"	Chisel	Galv	Plain	Straight Glued Strip	60M	C02BAAPN
3/16"	Chisel	Galv	Plain	Straight Glued Strip	55M	C03BAAPN
1/4"	Chisel	Galv	Plain	Straight Glued Strip	35M	C04BAAP
3/16"	Chisel	Galv	Plain	Straight Glued Strip	28M	C05BAAPN
3/8"	Chisel	Galv	Plain	Straight Glued Strip	50M	C06BAAP
7/16"	Chisel	Galv	Plain	Straight Glued Strip	40M	C07BAAPN
1/2"	Chisel	Galv	Plain	Straight Glued Strip	35M	C08BAAP
5/8"	Chisel	Galv	Plain	Straight Glued Strip	27M	C10BAAP
3/16"	Chisel	Stainless 304	Plain	Straight Glued Strip	25M	C03BGAN
1/4"	Chisel	Stainless 304	Plain	Straight Glued Strip	25M	C04BGAN
3/8"	Chisel	Stainless 304*	Plain	Straight Glued Strip	10M	C06BHA
3/8"	Chisel	Stainless 304	Plain	Straight Glued Strip	10M	C06BGA
1/4"	Chisel	Galv	Plain	Straight Glued Strip	5M	C04BAAR
3/8"	Chisel	Galv	Plain	Straight Glued Strip	5M	C06BAAR
1/2"	Chisel	Galv	Plain	Straight Glued Strip	5M	C08BAAR
5/8"	Chisel	Galv	Plain	Straight Glued Strip	5M	C10BAAR

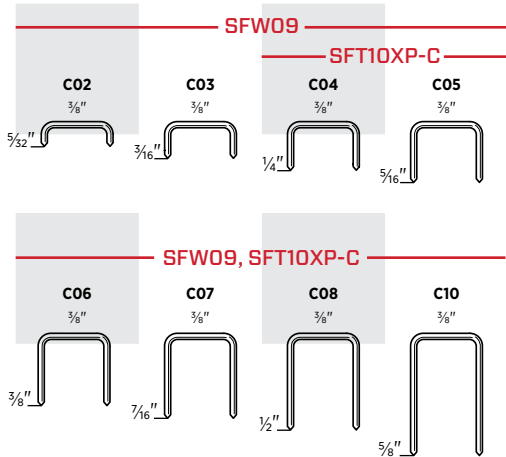

* High-Tensile 304 Stainless Steel

21^{BA}
W

3/16" Crown Fine Wire Staples

Furniture upholstery, felt, insulation, casebacks, screening and shoes

Length	Point	Finish	Coating	Collation	Box Count	Item Code
5/8"	Chisel	Galv	Sencote	Straight Glued Strip	10M	W10BAB

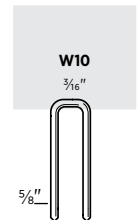

UPHOLSTERY & FURNITURE FASTENERS

20^{GA}
E

3/16" Crown Fine Wire Staples

Furniture upholstery, felt, insulation, casebacks, screening and shoes

Length	Point	Finish	Coating	Collation	Box Count	Item Code
3/8"	Chisel	Galv	Plain	Straight Glued Strip	10M	E06BAA
1/2"	Chisel	Galv	Plain	Straight Glued Strip	10M	E08BAA
5/8"	Chisel	Galv	Plain	Straight Glued Strip	5M	E10BAA

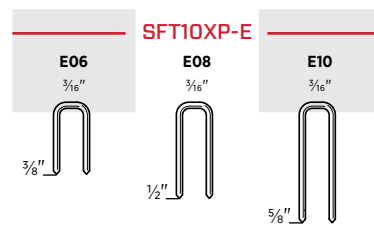

20^{GA}
F

1/2" Crown Fine Wire Staples

Upholstery, felt, insulation and casebacks

Length	Point	Finish	Coating	Collation	Box Count	Item Code
1/4"	Chisel	Galv	Plain	Straight Glued Strip	10M	F04BAAN
1/4"	Chisel	Galv	Plain	Straight Glued Strip	17M	F04BAAP
5/16"	Chisel	Galv	Plain	Straight Glued Strip	24M	F05BAAP
3/8"	Chisel	Galv	Plain	Straight Glued Strip	10M	F06BAA
3/8"	Chisel	Galv	Plain	Straight Glued Strip	24M	F06BAAP
1/2"	Chisel	Galv	Plain	Straight Glued Strip	10M	F08BAAN
1/2"	Chisel	Galv	Plain	Straight Glued Strip	15M	F08BAAP
3/8"	Chisel	Stainless 304	Plain	Straight Glued Strip	10M	F06BGA

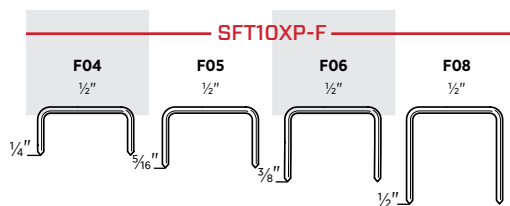

20^{GA}
G

3/8" Crown Fine Wire Staples

Upholstery, felt, insulation and casebacks

Length	Point	Finish	Coating	Collation	Box Count	Item Code
1/4"	Chisel	Galv	Plain	Straight Glued Strip	10M	G04BAAN
3/8"	Chisel	Galv	Plain	Straight Glued Strip	5M	G06BABN
1/2"	Chisel	Galv	Plain	Straight Glued Strip	5M	G08BAB

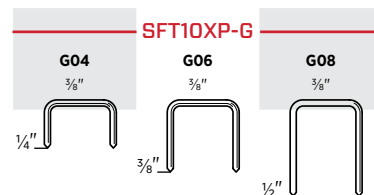

20^{GA}
H

7/16" Crown Fine Wire Staples

Upholstery, felt, insulation and casebacks

Length	Point	Finish	Coating	Collation	Box Count	Item Code
3/8"	Chisel	Galv	Plain	Straight Glued Strip	5M	H06BAA
3/8"	Chisel	Galv	Plain	Straight Glued Strip	1M	H06BAAPR



UPHOLSTERY & FURNITURE FASTENERS

16^{GA}
N

7/16" Crown Heavy Wire Staples

Cabinets, casebacks, drawers and upholstery

Length	Point	Finish	Coating	Collation	Box Count	Item Code
3/4"	Chisel	Bright	Sencote	Glued	5M	N11BRB
1"	Chisel	Bright	Sencote	Glued	5M	N13BRB
1 1/8"	Chisel	Bright	Sencote	Taped	10M	N14BRB
1 1/4"	Chisel	Bright	Sencote	Taped	10M	N15BRB
1 3/8"	Chisel	Bright	Sencote	Taped	10M	N16BRB
1 1/2"	Chisel	Bright	Sencote	Taped	10M	N17BRB
1 5/8"	Chisel	Bright	Sencote	Taped	10M	N18BRB
1 3/4"	Chisel	Bright	Sencote	Taped	10M	N19BRB
2"	Chisel	Bright	Sencote	Taped	10M	N21BRB
1/2"	Chisel	Galv	Sencote	Glued	5M	N08BABN
1/2"	Chisel	Galv*	Sencote	Glued	5M	N08BBBN
1/2"	Diverg	Galv*	Sencote	Glued	5M	N08FBBN
5/8"	Chisel	Galv	Sencote	Glued	5M	N10BAB
3/4"	Chisel	Galv	Sencote	Glued	5M	N11BAB
3/4"	Diverg	Galv*	Sencote	Glued	5M	N11FBBN
7/8"	Chisel	Galv	Sencote	Glued	5M	N12BABN
7/8"	Diverg	Galv	Sencote	Glued	5M	N12FABN
1"	Chisel	Galv	Sencote	Glued	5M	N13BAB
1"	Diverg	Galv	Sencote	Glued	5M	N13FAB
1 1/8"	Chisel	Galv	Sencote	Taped	10M	N14BAB
1 1/4"	Chisel	Galv	Sencote	Taped	10M	N15BAB
1 1/4"	Diverg	Galv	Sencote	Glued	10M	N15FAB
1 3/8"	Chisel	Galv	Sencote	Taped	10M	N16BAB
1 1/2"	Chisel	Galv	Sencote	Taped	10M	N17BAB
1 5/8"	Chisel	Galv	Sencote	Glued	10M	N18BAB
1 3/4"	Chisel	Galv	Sencote	Taped	10M	N19BAB
2"	Chisel	Galv	Sencote	Taped	10M	N21BAB
1 1/4"	Chisel	Stainless 304	Sencote	Glued	3M	N15BGB
1 1/2"	Chisel	Stainless 304	Sencote	Glued	3M	N17BGB
1 3/4"	Chisel	Stainless 304	Sencote	Glued	3M	N19BGBN
2"	Chisel	Stainless 304	Sencote	Glued	3M	N21BGBN

*Galvanized High-Tensile Steel

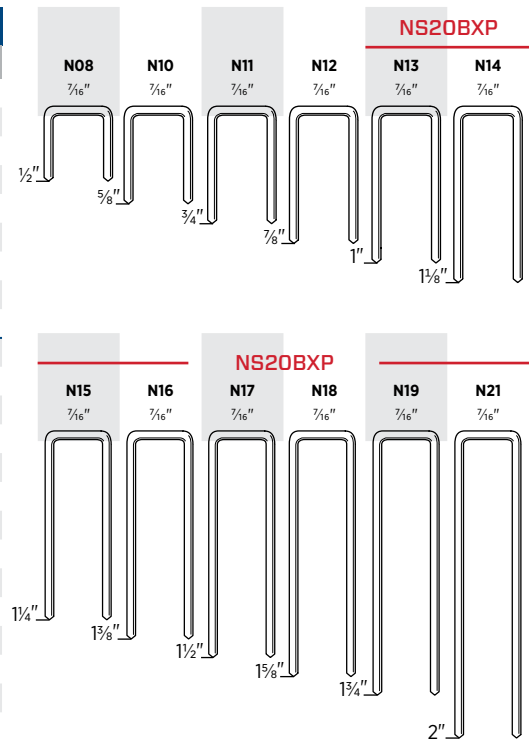

FLOORING

HARDWOOD FLOORING DONE RIGHT

Hardwood floors aren't so hard to install with our SHF200 stand-up flooring tool. With a long, ergonomic handle and a base that easily adjusts to any floor thickness, you will get your job done in no time. SENCO is committed to creating industry-leading flooring tools to make your job easier.



SHF200

2" PNEUMATIC MALLET ACTUATED
HARDWOOD FLOORING CLEAT NAILER

ITEM #8D0001N



Features

- Innovative non-marring base that adjusts between ½" and ¾" flooring without the use of tools
- Safety trigger prevents accidental ejection of fasteners
- Lightweight and well balanced, yet 5% more powerful than competitive flooring nailers
- Extra-long ergonomic handle reduces user fatigue

SLS20XP-HF

¾" CROWN, 1" ENGINEERED &
HARDWOOD FLOOR STAPLER

ITEM #490021N



Features

- NEVERLUBE® design — no oil required
- Front block easily adjusts to floor thickness
- Industry-exclusive safety controls staple placement
- Power-adjusted motor drives staples to consistent and controllable depth

Product Reference Chart

TOOL SPECS	SHF200	SLS20XP-HF
Trigger	Sequential	Sequential
Operating Pressure	90-110 psi (6.2-7.6 bar)	70-120 psi (4.8-8.3 bar)
Air Consumption (60 CPM)	2.52 scfm	1.92 scfm
Air Inlet	¼" NPT	¼" NPT
Weight	10.1 lbs (4.58 kg)	3.2 lbs (1.5 kg)
Height	21.5" (546 mm)	9" (228 mm)
Length	17.8" (452 mm)	13" (332 mm)
Width	3.1" (78 mm)	3" (76 mm)
Main Body Material	Aluminum	Aluminum
Warranty	5 yrs	5 yrs
FASTENER SPECS	Fasteners are located on page 68	
Gauge	16	19
Crown	L-Head	¾"
Range	1 ½"-2"	⅝"-1"
Capacity	107	168
Angled/Collation	Straight Glued Strip	Straight Glued Strip
Series	RW	R
FLOORING MATERIAL		
Hardwood	Yes	Yes
Hardwood Laminate	Yes	Yes
Board Thickness	½", ⅝", ¾", ⅜" (12-26 mm)	¼", ⅝", ⅜" (6-10 mm)



L-Head Flooring Cleat Nails

1/2", 5/8", 3/4", 33/32" Solid hardwood flooring						
Length	Point	Finish	Coating	Collation	Box Count	Item Code
1 1/2"	Blunt Diamond	Bright	N/A	Straight Glued Strip	1M	RW17BPE
1 3/4"	Blunt Diamond	Bright	N/A	Straight Glued Strip	1M	RW19BPE
2"	Blunt Diamond	Bright	N/A	Straight Glued Strip	1M	RW21BPE
2"	Blunt Diamond	Stainless 304	N/A	Straight Glued Strip	1M	RW21BGE

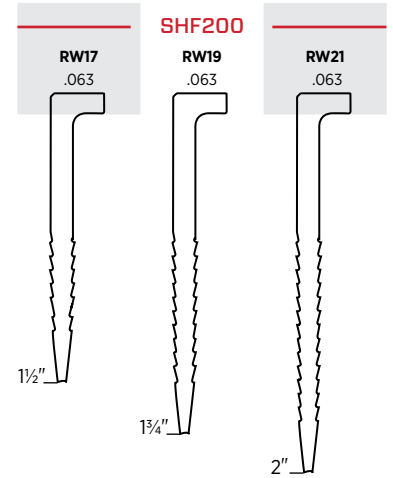

3/16" Crown Flooring Staples

1/4", 5/16", 3/8" Engineered and hardwood floors						
Length	Point	Finish	Coating	Collation	Box Count	Item Code
5/8"	Chisel	Galv	Sencote	Straight Glued Strip	5M	R10BAB
3/4"	Chisel	Galv	Sencote	Straight Glued Strip	5M	R11BAB
1"	Chisel	Galv	Sencote	Straight Glued Strip	5M	R13BAB

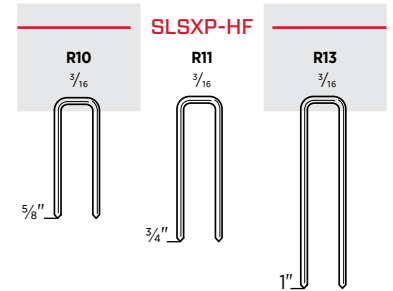

Get the Job Done.

With genuine SENCO compressors & accessories.

SENCO continuously strives to offer a wide selection of compressors, accessories, and parts to complete our full-line of fastening systems. Our commitment is to bring you the highest quality products to help you get the job done right.



COMPRESSORS

SENCO compressors are made to exacting standards. Only the highest quality components are used to provide the reliability expected from a SENCO product.

AIR HOSES

SENCO offers a wide variety of air hoses that allow you to choose the right solution for your job site. Our NEW Premium Hybrid hose provides the ultimate in flexibility and memory resistance, even in extremely cold temperatures. Quick Couple Rubber Hose is the standard for the professional on the job site with its tough flexible neoprene cover. ProFlex Reinforced Polyurethane Hose is the lightest weight non-marring flexible hose. PVC is resistant to lubricating oils, chemicals, and ultraviolet sunlight.



REGULATORS, GAUGES & LUBRICANTS

SENCO's assortments of regulators, gauges, oils and lubricants are chosen to satisfy the demanding requirements of the job site and deliver professional durability and quality. All will accurately replace the damaged component on SENCO units as well as many others.

PLUGS & COUPLERS

SENCO quick connect coupler and plug fittings are available in the most popular Industrial Interchange styles and sizes. Quick connect couplers are also available in the Universal style to work with other style plugs.



TOOL BELT HOOKS

SENCO offers a variety of belt hooks to allow the professional the ability to use both hands without worrying about dropping their pneumatic tool.

AIR COMPRESSORS & KITS

THE INNOVATION YOU'VE COME TO EXPECT, THE QUALITY YOU ALREADY KNOW

Whether you need an air compressor for punch-out jobs or for all-day performance, SENCO offers high quality, reliable options to meet your needs.

KEY FEATURES

SENCO has you covered with industry leading compressors that provide plenty of tank storage and air flow for the job site or professional shop. Many feature an oil-free pump design to reduce maintenance and have integrated panels that provide easy access to control knobs. There's even a compressor equipped with

dual couplers so you can run two hoses simultaneously. Count on quickly getting back to work - we offer compressors that have pump up times of less than 40 seconds. You can easily monitor output pressure with individual tank and outlet gauges.

A full line of hoses and accessories is also available.



PC1131

2 HP (RUNNING) 4.3 GALLON
TWIN TANK AIR COMPRESSOR



Features

- Cast-iron cylinder for superior pump life
- Compact twin stack tank design
- Heavy-duty induction motor

PC0968

1 HP (RUNNING) 2½ GALLON TWIN TANK
FINISH AND TRIM AIR COMPRESSOR



Features

- Compact twin stack tank design
- Lightweight — 38 lbs
- Heavy-duty induction motor

PC1280

1½ HP (RUNNING) 6 GALLON
FINISH AND TRIM AIR COMPRESSOR



Features

- Compact and balanced pancake tank design
- Lightweight — 38 lbs
- Dual quick connect couplers

PC1010

½ HP (RUNNING) 1 GALLON
FINISH AND TRIM AIR COMPRESSOR



Features

- Ultra-quiet — 68 dBA
- Ultra-light — 20 lbs
- Heavy-duty induction motor

PC1010N

½ HP (RUNNING) 1 GALLON
FINISH AND TRIM AIR COMPRESSOR



Features

- Ultra-quiet — 68 dBA
- Ultra-light — 21 lbs
- Heavy-duty induction motor

PC0947

2" FINISHPRO®18 BRAD NAILER
AND PC1010 COMPRESSOR KIT



Features

- 1 gallon PC1010 compressor
- 2" 18 gauge brad nailer
- Everything you need to get started

Air Compressor Reference Chart

SPECS	PC1131	PC0968	PC1280	PC1010	PC1010N
Motor	Induction	Induction	Universal	Induction	Induction
Amps	14	8	12	4	4
Power Source	115 Volts	115 Volts	115 Volts	115 Volts	115 Volts
SCFM @ 90 PSI	4.4	2.2	2.8	0.7	0.7
Max PSI	125	135	150	135	135
Weight	60 lbs (27 kg)	38 lbs (17.24 kg)	38 lbs (17.24 kg)	20 lbs (9.07 kg)	21 lbs (9.53 kg)
Height	14.5" (368 mm)	13.5" (343 mm)	18" (457 mm)	13" (330 mm)	12.25" (311 mm)
Length	20.5" (521 mm)	16" (406 mm)	17" (432 mm)	14" (356 mm)	11.5" (292 mm)
Width	16.5" (419 mm)	15" (381 mm)	16.3" (414 mm)	10" (254 mm)	14" (356 mm)
Warranty	1 yr	1 yr	1 yr	1 yr	1 yr
FEATURES					
Thermal Over-load Protector	Yes	Yes	Yes	Yes	Yes
Pump	Oil-Lube	Oil-Free	Oil-Free	Oil-Free	Oil-Free
Pump Up/Recovery Time	67 sec./16 sec.	82 sec./17 sec.	152 sec./33 sec.	125 sec./30 sec.	125 sec./30 sec.
¾" Quick Connect Coupler	1	1	2 (Dual)	1	1
Regulator	Yes	Yes	Yes	Yes	Yes
Individual Tank & Outlet Gauges	Yes	Yes	Yes	Yes	Yes
Cold Start Valve	Yes	No	No	No	No
CSA Approved	Yes	Yes	Yes	Yes	Yes

Tool Kit Ref. Chart

KIT SPECS	PC0947
Compressor	PC1010
Tool	FinishPro® 18
Trigger	Contact
Tool Operating Pressure	70-95 psi
Tool Air Inlet	¼" NPT
Tool Weight	3 lbs (1.6 kg)
Tool Height	9.3" (238 mm)
Tool Length	9.75" (248 mm)
Kit Warranty	1 yr
Coil Hose	¼" x 25'
Air Fittings	Yes
Tool Oil & Safety Glasses	Yes
Variety Pack of Fasteners	18 Ga. Brads
FASTENERS	
Gauge	18 Ga. Brads
Range	⅝"-2"

ACCESSORIES

FILTERS, REGULATORS, LUBRICANTS, PLUGS, COUPLERS, HOSES, PART KITS AND MORE

SENCO offers an assortment of accessories that are precision engineered to meet the demanding requirements of professionals. Be sure that your tools and compressors are running at peak performance by using SENC certified replacement parts, accessories, hoses, oils and lubricants.



Air Hoses

SENCO offers a wide variety of air hoses in various materials, sizes and specifications for your job site.

(FPT) - Female Pipe Thread
(MPT) - Male Pipe Thread

Quick Couple Rubber Hose

SENCO's premium air hoses:

- Can handle up to 250 psi working pressure
- Oil-resistant nitrile tube
- Braided textile reinforcing for max strength and kink resistance
- Remains flexible at temperatures from -40° to 200°F
- 4-to-1 working pressure to burst safety factor
- Tough, flexible neoprene cover

	Hose Size	Length	Qty.	ITEM #
Gray with Industrial Interchange Plug and Coupler Fittings	¼"	50 ft	1	PC0064
Gray with Industrial Interchange Plug and Coupler Fittings	¼"	100 ft	1	PC1152
Gray with Industrial Interchange Plug and Coupler Fittings	¾"	50 ft	1	PC0065



GRAY WITH PLUG & COUPLER
PC0064, PC1152,
PC0065

ProFlex™ Reinforced Polyurethane Red Air Hose

Lightest available non-marring flexible hose

- Flexible in all weather (-48° to 150°F)
- Working pressure: 250 psi
- Durable — oil and fuel resistant
- MPT-threaded ends

Description	Hose Size	Length	Qty.	ITEM #
ProFlex™ with MPT Ends (Use with FPT-Type Fittings)	¼"	50 ft	1	PC0977
ProFlex™ with MPT Ends (Use with FPT-Type Fittings)	¼"	100 ft	1	PC0978
ProFlex™ with MPT Ends (Use with FPT-Type Fittings)	¾"	50 ft	1	PC0979



PROFLEX WITH MPT ENDS
PC0977, PC0978,
PC0979

Premium Hybrid Polymer Air Hose

- Provides the ultimate in flexibility and memory resistance, even in extreme cold
- Offers the best combination of strength and flexibility on the market

Description	Hose Size	Length	Qty.	ITEM #
Hybrid with MPT Ends (Use with FPT-Type Fittings)	¼"	50 ft	1	PC1319
Hybrid with MPT Ends (Use with FPT-Type Fittings)	¼"	100 ft	1	PC1320
Hybrid Field-Repairable with MPT Ends (Use with FPT-Type Fittings)	¼"	50 ft	1	PC1321
Hybrid Field-Repairable with MPT Ends (Use with FPT-Type Fittings)	¼"	100 ft	1	PC1322
Hybrid Field-Repairable with MPT Ends (Use with FPT-Type Fittings)	¾"	50 ft	1	PC1339



HYBRID WITH MPT ENDS
PC1319, PC1320

Field Repairable End Fitting

- Field repairable hose ends are made with aircraft aluminum for easy on-site repair without hose clamps

Description	Hose Size	Qty.	ITEM #
Hybrid Hose Repair End Fitting	¼"	1	PC1341
Hybrid Hose Repair End Fitting	¾"	1	PC1337
Hybrid Hose Splicer	¼"	1	PC1338
Hybrid Hose Splicer	¾"	1	PC1340



HYBRID HOSE FIELD REPAIR KITS
END FITTING AND HOSE SPLICER KITS

Plugs & Couplers

Quick connect plugs and couplers are available in the most popular Industrial Interchange styles. Couplers are also available in Universal style.

Universal Couplers — push plug into coupler (no need to pull back on sleeve)

Type	Body Size	NPT Size	Pack Qty.	ITEM #
Female	¼"	¼" FPT	1	PC0900



FEMALE COUPLER
PC0900

Plugs — Industrial Interchange

Type	Body Size	Size	Pack Qty.	ITEM #
Male	¼"	¼" MPT	2	PC0479
Male	¼"	⅜" MPT	2	PC0480
Female	¼"	¼" FPT	2	PC0477
Female	¼"	⅜" FPT	2	PC0478
Push-on Barb	¼"	¼" LHB	1	PC0576
Push-on Barb	¼"	⅜" LHB	1	PC0577



MALE PLUG
PC0479, PC0480



FEMALE PLUG
PC0477,
PC0478



PLUG (PUSH-ON LOCKING BARB)
PC0576, PC0577

Couplers — Industrial Interchange

Type	Body Size	Size	Pack Qty.	ITEM #
Male	¼"	¼" MPT	1	PC0503
Male	¼"	⅜" MPT	1	PC0504
Female	¼"	¼" FPT	1	PC0501
Female	¼"	⅜" FPT	1	PC0502
Push-on Barb	¼"	¼" LHB	1	PC0505
Push-on Barb	¼"	⅜" LHB	1	PC0506



MALE COUPLER
PC0503, PC504



FEMALE COUPLER
PC0501, PC0502



COUPLER
(PUSH-ON LOCKING BARB)
PC0505, PC0506

Swivel Plugs & Swivel Couplers

- Allow easier access when working in corners and tight spaces
- Reduce fatigue
- Help prevent kinks and reduce stress on hose
- Provide strong and simple connection for pneumatic tools

Swivel Plugs — Industrial Interchange

Type	Body Size	NPT Size	Pack Qty.	ITEM #
Male	¼"	¼" MPT	2	PC1323
Male	¼"	⅜" MPT	2	PC1325



MALE SWIVEL PLUG
PC1323, PC1325

Swivel Couplers — Industrial Interchange

Type	Body Size	NPT Size	Pack Qty.	ITEM #
Female	¼"	¼" FPT	1	PC1328



FEMALE SWIVEL COUPLER
PC1328

Swivel Couplers — Universal

Type	Body Size	NPT Size	Pack Qty.	ITEM #
Female	¼"	¼" FPT	1	PC1330



FEMALE SWIVEL COUPLER
PC1330

(FPT) - Female Pipe Thread
(MPT) - Male Pipe Thread
(LHB) - Locking Hose Barb, no clamp required when used with SENCO Quick Couple Hose.

Air Hose Accessories

Splicer			
Description	Size	Pack Qty.	ITEM #
Push-On Barbed Hose Splicer	¼" LHB	2	PC0643



ProFlex Hose Fittings			
Description	Size	Pack Qty.	ITEM #
Brass Hose End	¼" MPT	1	PC0983
Brass Hose End and Splicer	¼" MPT	1	PC0987



Air Hose and Compressor Accessories

Tripod Manifold				
Description	Inlet Thread	Outlet Thread	Pack Qty.	ITEM #
3-Way Flat Manifold Industrial Interchange	¼" Plug	¼" Coupler	1	PC1138



Blow Gun			
Description	Inlet Thread	Pack Qty.	ITEM #
Air Blow Gun	¼" FPT	1	PC0489

(FPT) - Female Pipe Thread



Teflon® Thread Sealing Tape		
Description	Pack Qty.	ITEM #
½" x 260' Sealing Tape	1	PC0349



Regulators & Gauges

SENCO's assortment of filters and gauges are precision engineered to meet the demanding requirements of professional contractors. Be sure that your compressor is running at peak performance by using SENCO-certified replacement parts and accessories.

Air Regulation Accessories: Regulator with Gauge					
Description	Max PSI	Max Airflow	FPT Size	NPT Gauge	ITEM #
Mini Regulator with Gauge	250	14 SCFM	¼"	⅛"	PC0656
Regulator with Gauge	300	80 SCFM	⅜"	⅛"	PC0657
Back-Mount Pressure Gauge	160	—	—	⅛"	PC0057
Back-Mount Pressure Gauge	160	—	—	¼"	PC0051



Oils & Lubricants

Oils and Lubricants				
Description	Features	Size	Case Qty.	ITEM #
Pneumatic Tool Oil (½ pt)	<ul style="list-style-type: none"> Premium-grade oil with high-quality paraffin distillate stock Contains a carefully balanced rust and oxidation inhibitor with an effective anti-foaming additive 	8 oz	12	PC0101
Pneumatic Tool Oil (1 qt)	<ul style="list-style-type: none"> Premium-grade oil with high-quality paraffin distillate stock Contains a carefully balanced rust and oxidation inhibitor with an effective anti-foaming additive 	32 oz	12	PC0102
Pneumatic Tool Oil (1 gal)	<ul style="list-style-type: none"> Premium-grade oil with high-quality paraffin distillate stock Contains a carefully balanced rust and oxidation inhibitor with an effective anti-foaming additive 	128 oz	4	PC0103
Compressor Pump Oil (1 qt)	<ul style="list-style-type: none"> Premium-grade oil with high-quality naphthenic distillate stock Recommended for all oil-splash compressors Protects against corrosion Lubricates to extend part life 	32 oz	12	PC0344
Moisture Shield Tool Lubricant (1 qt)	<ul style="list-style-type: none"> For use in cold weather and/or high-moisture areas Protects against corrosion Lubricates to extend part life Special additive to minimize exhaust fog 	32 oz	12	PC1295
Tool Lubricant	<ul style="list-style-type: none"> Protects against corrosion Lubricates to extend part life Special additive to minimize exhaust fog 	4 oz	12	YB0123



Safety Glasses & Tool Belt Hooks

Safety Glasses		
Description	Qty.	ITEM #
Wrap-Around Safety Glasses*	10-Case	PC1166

*Filters 99% of UVA and UVB rays. Meets or exceeds ANSI Z87.1 and CE EN 166 safety standards. For indoor and outdoor use.



Tool Belt Hooks			
Description	Size	Qty.	ITEM #
Attaches to ¼" Air Fitting on Tool	Standard	1	PC0350
Attaches to ¼" Air Fitting on Tool	X-Wide	1	PC0629
Attaches to ⅜" Air Fitting on Tool	Standard	1	PC0351
Attaches to ⅜" Air Fitting on Tool	X-Wide	1	PC0630





Extended Length Magazines

Extended Length Magazine for Cordless Pneumatic Framers	
Tool	ITEM #
F-35XP	GA0767
F-35FRHXP	GA0778





Li-Ion Batteries

For use with 18V Li-Ion cordless screwdrivers and cordless pneumatic tools		
18V Li-Ion Battery 2.0 amp hour	For use with	
VB0212		 <ul style="list-style-type: none"> High-quality reliable cells Charges to 50% in less than 20 minutes and 100% in less than 60 minutes with VB0156
18V Li-Ion Battery 3.0 amp hour	DS222-18V DS225-18V DS322-18V F-15XP F-16XP F-18XP F-LXP F-35XP* F-35FRHXP*	
VB0190		 <ul style="list-style-type: none"> State of the art 21700 cells Charges to 50% in less than 20 minutes and 100% in less than 60 minutes with VB0189
18V Li-Ion Battery 4.0 amp hour		
VB0210		 <ul style="list-style-type: none"> State of the art 21700 cells Charges to 50% in less than 20 minutes and 100% in less than 60 minutes with VB0189

*For optimal performance only use the VB0190 or VB210 battery with the F-35XP and F-35FRHXP

Battery Chargers

For use with SENCOR batteries		
Battery Charger	For use with	
VB0156		 <ul style="list-style-type: none"> 3 amp quick charger Battery charge indicators display charge status of your battery
Battery Charger	VB0155 VB0212 VB0190** VB0210**	
VB0189		 <ul style="list-style-type: none"> 5 amp quick charger Upright design is ideal for wall mounting

**The VB0189 charger is recommended for the VB0210 and VB0190 batteries; using the VB0156 charger will result in longer charge times

Replacement No-Mar Pads



Replacement No-Mar Pads Fit	ITEM #
AF25, CF25	HF0064
AF41, CF41	HF0079
FIP11	HC0463
FIP15, FIP18	HC0506
FIP15Mg, BN31M1P	HC0571
FIP23SXP, 23LXP, 21LXP	HC0729
FIP25XP	HF0064
FIP32*	HC0396
FIP32*	HC0401
FIP41XP, FIP42XP	HF0079
FN55AX	HF0113
FN65DA	HF0110
FP600-650 SERIES	HF0046, HC0253
FP601, FP602, FP651, FP652	HA0170
FP700 SERIES	HF0046, HC0253

One pad per pack

*Refer to parts chart to identify desired safety element design

Replacement No-Mar Pads Fit	ITEM #
GT65DA	HC0626
GT65RHA	HC0625
GT90CH	HA0200
GT90FRH	HA0201
SCN49	HC0536
SFN30, SFN40, SFNI	HF0079
SLS15, SLS18	HC0507
SLS15Mg, LS61H1P	HC0572
SLS20, SLS20XP (K, L & R CROWNS)	HF0028
SLS20, SLS20XP (M CROWN)	HF0029
SLS25-L, SLS25XP-L	HF0028

One pad per pack

Maintaining Your Tools

SENCO repair kits are designed to provide the parts normally needed to properly maintain and service your SENCO tools.



Tool Model	Description	Item Code
FinishPro15, 18, 2N1	Repair Kit	YK0393
FinishPro15Mg, BN31M1P	Repair Kit	YK0780
BN31M1P	Repair Kit	YK0908
TN41P1P	Repair Kit A	YK0906
TN41P1P	Repair Kit B	YK0907
FinishPro18BMg	Repair Kit	YK0868
FinishPro21LXP, 23LXP	Repair Kit	YK0855
FinishPro23SXP	Repair Kit	YK0854
FinishPro25XP	Firing System Kit	YK0281
FinishPro25XP	Piston Stop Kit	YK0282
FinishPro32	Repair Kit	YK0394
FinishPro33Mg	Repair Kit	YK0787
TN51P1P	Repair Kit	YK0905
FinishPro41XP, 42XP	Firing System Kit	YK0361
FinishPro41XP, 42XP	Piston Stop Kit	YK0362
FramePro601, 602, 651, 652	Repair Kit	YK0360
FramePro XP 701, 752, 702, 752	Firing System Kit	YK0243
FramePro XP 701, 752, 702, 752	Piston Stop Kit	YK0244
HN150, HN250	Repair Kit	BA0158
JoistPro150XP	Firing System Kit	YK0823
JoistPro150XP	Piston Stop Kit	YK0824
JoistPro250XP	Firing System Kit	YK0825
JoistPro250XP	Piston Stop Kit	YK0826
JoistPro250XP	Safety Upgrade Kit	YK0869
LS1XP	Repair Kit	YK0858
MW	Repair Kit	YK0371
NS20XP	Firing System Kit	YK0840
NS20XP	Piston Stop Kit	YK0841
NS20XP	Siding Safety Kit	HC0788
NS20BXP	Firing System Kit	YK0838
NS20BXP	Piston Stop Kit	YK0839
PAL57FXP	Repair Kit	YK0446
PS15XP, PS15RXP	Repair Kit	YK0784
PS15XP, PS15RXP	Repair Kit	YK0818
PS15XP, PS15RXP	Block Out Kit	YK883
PS15XP	Retrofit Kit - Solid Safety	YJ0044
PS15RXP	Retrofit Kit - Solid Safety	YJ0049
PS20XP	Repair Kit	YK0783
RoofPro™ 455XP	Firing System Kit	YK0424
RoofPro™ 445XP	Repair Kit	YK0865
RoofPro™ 445XP	Wear Guard Kit	YK0870
RoofPro™ 445XP	Gate Repair Kit	YK0871
RoofPro™ 455XP	Piston Stop Kit	YK0425
RoofPro™ 450XP	Repair Kit	YK0426
SC 1	Repair Kit	YK0370
SC 2	Repair Kit	YK0371
SCN48	Repair Kit	YK0769
SCN49	Repair Kit	YK0771
SCN60, SCN65	Seal Kit	YK0366

Tool Model	Description	Item Code
SFN1, SKS, SPS	Repair Kit	YK0376
SFN1, SKS, SPS	Retrofit Kit	YJ0035
SFN30	Repair Kit	YK0368
SFT10XP, SFT10XP D/L, SFT10XP LN	Piston Stop Kit	YK0802
SFT10XP, SFT10XP D/L, SFT10XP LN	Firing System Kit	YK0803
SFT10XP (AUTO)	Firing System Kit	YK0804
SFT10XP (AUTO D/L)	Firing System Kit	YK0804
SFT10XP (AUTO D/L)	Piston Stop Kit	YK0802
SKSXP	Firing System Kit	YK0804
SFW09	Repair Kit	YK0775
SFW10XP	Piston Stop Kit	YK0321
SFW10XP	Firing System Kit	YK0322
SLP20	Repair Kit	YK0373
SLS15Mg, LS61HIP	Repair Kit	YK0780
LS61HIP	Repair Kit	YK0908
SLS20XP	Repair Kit	YK0372
SLS25XP	Piston Stop Kit	YK0291
SLS25XP	Firing System Kit	YK0359
SLS150Mg	Repair Kit	YK0852
SCP40XP	Firing System Kit	YK0444
SCP40XP	Piston Stop Kit	YK0445
SN901/902XP, FP325/325FRHXP	Firing System Kit	YK0444
SN901/902XP, FP325/325FRHXP	Piston Stop Kit	YK0445
SN951XP, SN952XP	Firing System Kit	YK0444
SN951XP, SN952XP	Piston Stop Kit	YK0768
SNS40	Repair Kit	YK0374
SNS41	Repair Kit	YK0423
SNS41 (Retrofit Kit)	Cap/Firing Valve	YJ0034
SNS41	Driver/Back Plate Upgrade	YK0794
SNS44XP	Firing System Kit	YK0421
SNS44XP	Piston Stop Kit	YK0422
SNS44XP	Driver/Back Plate Upgrade	YK0793
SNS45XP	Piston Stop Kit	YK0231
SNS50XP, SQS55XP	Seal Kit	YK0375
SNS200XP-BST	Firing System Kit	YK0838
SNS200XP-BST	Piston Stop Kit	YK0839
SNS200XP-BST	Wider Driver Kit	YK0873
SNS200XP	Firing System Kit	YK0840
SNS200XP	Piston Stop Kit	YK0841
SNS200XP	Block-Out Kit	YK0850
SNS200XP	Wider Driver Kit	YK0872
SNS200XP	Siding Safety Kit	HC0748
TN11G1	Repair Kit	YK0888
TN11L1, TN 21L1	Repair Kit	YK0889
TN11G1P	Repair Kit	YK0910
WC200XP	Piston Stop Kit	YK0784
WC200XP	Repair Kit	YK0783
WC200XP	Block-Out Kit	YK0786
WC200XP	Retrofit Kit - Solid Safety	YJ0037

BRIGHT BASIC

Bright Basic fasteners are an uncoated steel, which is commonly used in applications where corrosion protection is not required such as interior framing, finish and trim. These fasteners are not recommended for use in treated lumber or exterior applications.



GOOD
CORROSION
RESISTANCE

ELECTRO GALVANIZED

Electro Galvanized fasteners have a thin layer of zinc coating that helps corrosion resistance in mild weather conditions and in areas with lower humidity. Because of its minimal protective properties these fasteners are recommended for interior use in areas such as kitchens and bathrooms.



GOOD
CORROSION
RESISTANCE

HOT DIPPED GALVANIZED

Hot Dipped Galvanized nails have one ounce per square foot of zinc coating. The zinc coating on the nail acts as a barrier between the base steel and the elements, slowing the corrosion process. Ideal for preservative-treated wood and most exterior applications.



BETTER
CORROSION
RESISTANCE

304 STAINLESS STEEL

304 Stainless Steel contains 18% chromium and 8% nickel among other elements, making it resist most oxidizing acids and rust. An excellent choice for all types of environments and woods including exotic woods, cedar or redwood.

Recommended use: Exposure to wet conditions regularly and more than 5 miles away from a body of water.



BEST
CORROSION
RESISTANCE

DURASPIN® Collated Screwdrivers

Model	Item #	Page
DS222-18V - 2" Cordless 18v Li-Ion 2500 RPM	10B0002N	3
DS225-18V - 2" Cordless 18v Li-Ion 5000 RPM	10A0002N	3
DS242-AC - 2" Corded 2500 RPM	10E0001N	4
DS245-AC - 2" Corded 5000 RPM	10D0001N	4
DS322-18V - 3" Cordless 18v Li-Ion 2500 RPM	10C0002N	3
DS342-AC - 3" Corded 2500 RPM	10F0001N	4
SG2510 - High-Performance 2500 RPM Screwdriver	6X0002N	7
SG4100 - High-Performance 4000 RPM Screwdriver	6X0004N	7

DURASPIN® Attachments & Kits

Model	Item #	Page
DS230-D1 - 2" Auto-Feed Screwdriver Attachment	9Z0011N	5
DS230-D2 - 2" Auto-Feed Screwdriver Attachment	9Z0012N	5
DS230-M1 - 2" Auto-Feed Screwdriver Attachment	9Z0021N	5
DS230-S1 - 2" Auto-Feed Screwdriver Attachment	9Z0001N	5
DS530-D1 - 3" Auto-Feed Screwdriver Attachment	10X0012N	6
DS530-M1 - 3" Auto-Feed Screwdriver Attachment	10X0022N	6
DS530-S1 - 3" Auto-Feed Screwdriver Attachment	10X0002N	6
DS532-AC - 3" Attachment Kit with 2500 RPM Screwdriver	10X0003N	6
DS534-AC - 3" Auto-Feed Screwdriver Attachment	10X0013N	6

Pneumatic Tools

Model	Item #	Page
A11 - 7/16" Crown 3/8" Hammer Stapler	PC0700	50
A20 Hand Nailer - 2" - 7" Bulk Nailer	PC0781	35
BC58 - 1/2" Crown 3/8" Staple + 1" Cap	4A0001N	50
BN31MIP - 2 1/4" Brad Nailer	BN31MIP	17
DFPXP - 20 GA. 1/2" Crown, 1/2" Staple Clinch Tool	8H0001N	56
F-15XP - 2 1/2" 15 GA. Cordless Pneumatic Finish Nailer	10L0001N	15
F-16XP - 2 1/2" 16 GA. Cordless Pneumatic Finish Nailer	10N0001N	15
F-18XP - 2 1/2" 18 GA. Cordless Pneumatic Finish Nailer	10M0001N	15
F-35FRHXP - Cordless Pneumatic Framing Nailer	10H0002N	31
F-35XP - Cordless Pneumatic Framing Nailer	10G0002N	31
F75LXP - 18 GA. 7/16" Crown, 3/8" Staple Clinch Tool	8J0002N	56
F75SXP - 18 GA. 7/16" Crown, 3/8" Staple Sisal Anvil	8J0001N	56
FinishPro®18BMg - 2 1/4" Brad Nailer	9B0001N	17
FinishPro®25XP - 2 1/4" Brad Nailer	760102N	18
FinishPro®30XP - 2" Angled Finish Nailer	9P0002N	19
FinishPro®42XP - 2 1/2" Angled Finish Nailer	4G0001N	19
F-LXP - 1 1/2" 18 GA. 1/4" Crown Cordless Pneumatic Finish Stapler	10Y0001N	15
FN81T1 - 3 1/2" Full Round Head Framing Nailer	FN81T1	32
FN91T1 - 3 1/2" Paper Tape Framing Nailer	FN91T1	32
FramePro®325FRHXP - 3 1/4" Full Round Head Framing Nailer	4H0101N	34
FramePro®325XP - 3 1/4" Paper Tape Framing Nailer	4Z0101N	33
FramePro®701XP - 3 1/2" Paper Tape Framing Nailer	2H0133N	33
FramePro®702XP - 3 1/2" Full Round Head Framing Nailer	2K0103N	34
FramePro®751XP - 3 1/2" Paper Tape Framing Nailer	2J0103N	33
FramePro®752XP - 3 1/2" Full Round Head Framing Nailer	2F0103N	34
JN91H1 - 1 1/2" Metal Connector Nailer	JN91H1	36
JN91H2 - 1 1/2" Metal Connector Nailer	JN91H2	36
JN91P1 - 1 1/2"-2 1/2" Metal Connector Nailer	JN91P1	36
LS61H1P - 1/4" Crown, Medium Wire Finish Stapler	LS61H1P	21
NS20BXP - 7/16" Crown, Heavy Wire Stapler	9Y0001N	38, 62
NS20XP - 7/16" Crown, 2" Heavy Wire Stapler	9X0001N	38
PalletPro™100XP - 4" Coil Nailer (Special Order Tool)	5L0001N	55
PalletPro™130XP - 5 1/8" Coil Nailer (Special Order Tool)	5M0001N	55
PalletPro™57FXP - 2 1/4" Coil Nailer	4L0001N	55
PS15RXP - 1" Crown 1 1/2" Roofing Stapler	9U0001N	50
PS15XP - 1" Wide Crown, 1 1/2" Heavy Wire Stapler	9T0001N	37
PS20XP - 1" Wide Crown, 2" Heavy Wire Stapler	9W0001N	37
RoofPro™445XP - 1 3/4" Coil Nailer	8V0001N	49
SC1XP Senclamp® - 7/16" Crown, 3/8" Senclamp® Fastener	220101N	22
SC2 Sencor® - 1" Crown, 1/2" Corrugated Stapler	470001N	22
SCN60XP - 2 3/4" Coil Nailer	520101N	35
SCN65XP - 3 1/2" Coil Nailer (Flat Safety)	540101N	35
SCN65XP - 3 1/2" Coil Nailer (Toenail Safety)	540104N	35

Pneumatic Tools

Model	Item #	Page
SCP40XP - 1 1/2" Stnd. Pressure Pneumatic Concrete & Steel Pinner	7J0009N	37
SFT10XP 20 GA. E Wire - Standard	6S0031N	61
SFT10XP 20 GA. F Wire - Standard	6S0041N	61
SFT10XP 20 GA. G Wire - Standard	6S0051N	61
SFT10XP 22 GA. C Wire - Standard	6S0021N	61
SFT10XP 22 GA. A/D Wire - Auto	6S0101N	61
SFT10XP 22 GA. A/D Wire - Standard	6S0001N	61
SFT10XP 22 GA. B Wire - Standard	6S0011N	61
SFT10XP 22 GA. C Wire - Auto	6S0121N	61
SFT10XP Dbl. Length Mag. 20 GA. F Wire - Auto	6S0341N	61
SFT10XP Dbl. Length Mag. 20 GA. G Wire - Standard	6S0251N	61
SFT10XP Dbl. Length Mag. 20 GA. H Wire - Auto	6S0361N	61
SFT10XP Dbl. Length Mag. 22 GA. B Wire - Auto	6S0311N	61
SFT10XP Dbl. Length Mag. 22 GA. B Wire - Standard	6S0211N	61
SFT10XP Dbl. Length Mag. 22 GA. C Wire - Auto	6S0321N	61
SFT10XP Dbl. Length Mag. 22 GA. C Wire - Standard	6S0221N	61
SFT10XP Long Nose 22 GA. C Wire - Standard	6S0421N	61
SFW09 - 3/8" Crown, 5/8" Fine Wire Stapler	4C0001N	62
SHF200 - 2" Pneumatic Mallet Actuated Flooring Cleat Nailer	8D0001N	67
SKSXP-L Stapler	300120N	20
SKSXP-M Stapler	300152N	20
SKSXP-N Stapler	300184N	20
SLP20XP - 1 1/2" Brad Nailer	430101N	18
SLS150MG - 1/4" Crown, 1 1/8" Medium Wire Stapler	8C0001N	21
SLS20XP-HF - 3/16" Crown, 1" Floor Stapler	490021N	67
SLS20XP-K Stapler	490101N	20
SLS20XP-L Stapler	490103N	20
SLS20XP-L Sencomatic Stapler	490015N	20
SLS20XP-L Stapler With Case	490105N	20
SLS20XP-P Stapler	490107N	20
SLS20XP-R Stapler	490111N	20
SLS25XP-L Stapler	820103N	20
SLS25XP-M Stapler	820107N	20
SN71P1 - 2 1/2" Coil Nailer	SN71P1	49
SNS41 - 3/16" Crown, 2" Heavy Wire Stapler	3L0003N	38
SQS55XP - 7/16" Crown, 2 1/2" Heavy Wire Stapler	660101N	38
SQS55XP - 7/16" Crown, 2 1/2" Heavy Wire Stapler	660101N	38
TN11G1 - 1 3/8" Headless Pinner	TN11G1	16
TN11G1 - 1 3/8" Headless Pinner	TN11G1	16
TN11G1P - 1 3/8" Headless Pinner	TN11G1P	16
TN11L1 - 2" Headless Pinner	TN11L1	16
TN11L1 - 2" Headless Pinner	TN11L1	16
TN21L1 - 2" Pinner	TN21L1	17
TN21L1 - 2" Pinner	TN21L1	17
TN41P1P - 2 1/2" Finish Nailer	TN41P1P	18
TN51P1P - 2 1/2" Angled Finish Nailer	TN51P1P	19

Compressors & Kits

Model	Item #	Page
PC0947 - 2" FinishPro®18 Brad Nailer & PC1010 Compressor Kit	PC0947	71
PC0968 - 1 HP (Running) 2 1/2 Gal. Twin tank Air Compressor	PC0968	71
PC1010 - 1/2 HP (Running) 1 Gal. Air Compressor	PC1010	71
PC1010N - 1/2 HP (Running) 1 Gal. Air Compressor	PC1010N	71
PC1131 - 2 HP (Running) 4.3 Gal. Twin Tank Air Compressor	PC1131	71
PC1280 - 1 1/2 HP (Running) 6 Gal. Air Compressor	PC1280	71

Battery & Charger Systems

Model	Item #	Page
VB0156 - Battery Charger	VB0156	77
VB0189 - Battery Charger	VB0189	77
VB0190 - 18V Li-Ion Battery 3.0 amp hour	VB0190	77
VB0210 - 18V Li-Ion Battery 4.0 amp hour	VB0210	77
VB0212 - 18V Li-Ion Battery 2.0 amp hour	VB0212	77

ITEM CODE INDEX

Nails

Item Code	Boxes Per Carton	Boxes Per Skid	Page
A109809R	6	1080	23
A209809R	8	1152	23
A209909R	6	768	23
AX10EAA	16	480	23
AX11EAA	16	480	23
AX11EAAR	8	1152	23
AX13EAA	10	300	23
AX13EAAR	8	1152	23
AX15EAA	10	300	23
AX15EAAR	8	1152	23
AX17EAA	8	240	23
AX17EAAR	6	768	23
AX18EAA	8	240	23
AX19EAA	6	180	23
AX21EAAN	6	180	23
AX21EAAR	6	768	23
AX22EAAN	6	180	23
AX22EAAR	6	768	23
AY10EAA	16	480	24
AY11EAA	16	480	24
AY13EAA	10	300	24
AZ08EAA	32	960	24
AZ11EAA	24	720	24
AZ13EAA	16	480	24
BD17APBC	N/A*	24	51
BE23AABF	N/A*	45	43, 58
BG17AAAQ	N/A*	40	44
BG18AAAQ	N/A*	40	44
BK21BPBFN	N/A*	35	44, 59
BK23BPBFN	N/A*	35	44, 59
BK25BPBFN	N/A*	35	44, 59
BL21APBF	N/A*	45	43, 58
BT21APBF	N/A*	45	42, 43, 58
CZ08EAAN	N/A*	140	23
CZ08EAAR	6	1080	23
CZ10EAA	24	1440	23
CZ10EAAN	N/A*	140	23
CZ10EAAR	6	1080	23
CZ11EAA	24	1152	23
CZ11EAAN	N/A*	140	23
CZ11EAAR	6	1080	23
CZ13EAA	12	720	23
CZ13EAAR	6	1080	23
CZ15EAA	12	720	23
CZ15EAAR	6	1080	23
CZ16EAA	12	720	23
CZ16EAAR	6	1080	23
CZ17EAA	12	720	23
CZ17EAAR	6	960	23
CZ21EAA	12	576	23
CZ21EAAR	6	960	23
DA13EABR	6	504	25
DA13EPBN	5	200	25
DA13EPBR	6	504	25
DA15AIA	5	200	25
DA15EABN	5	200	25
DA15EABR	6	504	25
DA15EPBN	5	200	25
DA15EPBR	6	504	25
DA17AIA	5	200	25
DA17EABN	5	200	25
DA17EABR	6	504	25
DA17EPBN	5	200	25
DA17EPBR	6	504	25
DA19AIA	4	160	25
DA19EABN	4	160	25
DA19EABR	5	420	25
DA19EPBN	4	160	25
DA19EPBR	5	420	25
DA21EABN	4	160	25
DA21EABR	5	420	25
DA21EGBR	5	420	25
DA21EPBN	4	160	25

Nails

Item Code	Boxes Per Carton	Boxes Per Skid	Page
DA21EPBR	5	420	25
DA23EPBN	3	120	25
DA25EAB	3	120	25
DA25EABR	4	336	25
DA25EGBR	4	336	25
DA25EPB	3	120	25
DA25EPBR	4	336	25
ED23AABH	N/A*	60	51, 57
EJ21ADBH	N/A*	40	51, 57
EJ23ADBH	N/A*	40	51
EJ23ASBC	N/A*	24	51
EL19AGBH	N/A*	60	52, 58
EL19ASBH	N/A*	60	52, 58
EL20AABH	N/A*	60	52, 58
EL20ASBH	N/A*	60	52, 58
EL21AGBH	N/A*	60	52, 58
EL21ASBH	N/A*	60	52, 58
EL23AABH	N/A*	60	52, 58
EL23AGBH	N/A*	60	52, 58
EL23ASBC	N/A*	24	52
EL23ASBH	N/A*	60	52, 58
G524APBXN	N/A*	72	39
G524ASBXN	N/A*	72	39
G621ASBXN	N/A*	80	39
G624APBXN	N/A*	72	39
G624ASBXN	N/A*	72	39
G624ASBXNR	4	192	39
GC21APBX	N/A*	80	40
GC23AHAK	N/A*	80	40
GC24APBX	N/A*	72	40
GC24ASBX	N/A*	72	40
GC25APBX	N/A*	72	40
GD21AABF	N/A*	40	43, 57
GD21APBF	N/A*	40	43, 57
GD24APBSN	N/A*	48	41
GD24ASBS	N/A*	45	41
GD25AABF	N/A*	40	43, 57
GD25AABSN	N/A*	48	41
GD25APBF	N/A*	40	43, 57
GD25APBSN	N/A*	48	41
GE21APAX	N/A*	80	40
GE21ASBX	N/A*	80	40
GE24AGBK	N/A*	80	40
GE24APBX	N/A*	72	40
GE24ASBX	N/A*	72	40
GL21APBF	N/A*	40	43, 58
GL21APBSN	N/A*	48	42
GL21ASBS	N/A*	45	42
GL24AABSN	N/A*	48	42
GL24AGBF	N/A*	24	43, 58
GL24AGBS	N/A*	72	42
GL24APBF	N/A*	40	43, 58
GL24APBSN	N/A*	48	42
GL24ASBF	N/A*	40	43, 58
GL24ASBS	N/A*	45	42
GL24ASBSNR	4	192	42
GT24APBF	N/A*	40	42, 58
H527APBXN	N/A*	48	39
H527APBXNR	3	120	39
H528APBXN	N/A*	48	39
H627APBXN	N/A*	48	39
H627ASBXN	N/A*	48	39
H627ASBXNR	3	120	39
HC27APBX	N/A*	48	40
HC27ASBX	N/A*	48	40
HC28APBX	N/A*	48	40
HD27APBF	N/A*	40	43, 57
HD27APBSN	N/A*	48	41
HE27ASBX	N/A*	48	40
HF27EDB	N/A*	80	40
HF27EPAK	N/A*	40	40
HJ25ADBS	N/A*	45	41
HK27APBFN	N/A*	35	44, 59

Nails

Item Code	Boxes Per Carton	Boxes Per Skid	Page
HL27AGBS	N/A*	54	42
HL27ASBF	N/A*	40	43, 58
HL27ASBS	N/A*	40	42
HR22APAF	N/A*	40	44
HR74APAF	N/A*	40	44
K525APBXN	N/A*	72	39
K527APBXN	N/A*	48	39
K527APBXNR	3	120	39
K527APBXR	N/A*	80	39
K527ASBXN	N/A*	48	39
K527ASBXNR	3	120	39
K528APBXN	N/A*	48	39
K528APBXNR	3	120	39
K528APBXR	N/A*	80	39
K528ASBXN	N/A*	48	39
K528ASBXNR	3	120	39
K529APBXN	N/A*	48	39
K627ASBXN	N/A*	48	39
K628APBXN	N/A*	48	39
K628ASBXN	N/A*	48	39
K629ASBXN	N/A*	48	39
KC27AGBK	N/A*	80	40
KC27APBX	N/A*	48	40
KC27ASBX	N/A*	48	40
KC28AGBK	N/A*	80	40
KC28APBX	N/A*	48	40
KC28ASBX	N/A*	48	40
KC29APBX	N/A*	48	40
KC29ASBX	N/A*	48	40
KC31APBX	N/A*	40	40
KD25AABS	N/A*	45	41
KD25APBF	N/A*	40	43, 57
KD25APBSN	N/A*	48	41
KD27APBF	N/A*	40	43, 57
KD27APBSN	N/A*	48	41
KD27APBSNR	3	96	41
KD27ASBF	N/A*	24	43, 57
KD27ASBS	N/A*	40	41
KD27ASBSNR	3	96	41
KD28AGBS	N/A*	54	41
KD28APBF	N/A*	40	43, 57
KD28APBSN	N/A*	48	41
KD28APBSNR	3	96	41
KD28ASBF	N/A*	24	43, 57
KD28ASBS	N/A*	40	41
KD28ASBSNR	3	96	41
KD29APBF	N/A*	40	43, 57
KD29APBSN	N/A*	48	41
KD29ASBS	N/A*	40	41
KJ17AEBD	N/A*	100	45
KJ17AHBD	3	900	45
KT25APBF	N/A*	40	42, 58
LC29APBX	N/A*	48	40
M001000	20	960	24
M001000R	5	840	24
M001001	16	768	24
M001001R	5	840	24
M001002	6	480	24
M001002R	5	840	24
M001003	6	480	24
M001003R	5	840	24
M001004	6	384	24
M001004R	4	640	24
M001005	6	384	24
M001005R	4	640	24
M001006R	4	480	24
M001007	6	288	24
M001007R	4	480	24
M002261	N/A*	100	45
M002262	N/A*	100	45
M002263	N/A*	100	45
M002264	N/A*	100	45
M002265	N/A*	100	45

*Product is shipped in the item box, not in a master shipping carton.

Nails

Item Code	Boxes Per Carton	Boxes Per Skid	Page
M002266	N/A*	100	45
M003011	N/A*	24	44
M003101	N/A*	56	51
M003103	N/A*	56	51
M003104	N/A*	48	51
M003105	N/A*	40	51
M003106	N/A*	40	51
MD17AJBDN	N/A*	96	45
MD17AQBD	N/A*	96	45
MD25AHBD	N/A*	100	45
MD25AJBDN	N/A*	96	45
MD25AQBDN	N/A*	96	45
MD27APBSN	N/A*	36	41
MD28APBSN	N/A*	36	41
MD34APBF	N/A*	36	43, 57
ND25AJBDN	N/A*	96	45
ND25AQBDN	N/A*	96	45
P13GBN	N/A*	60	53
RW17BPE	10	510	68
RW19BPE	10	510	68
RW21BGE	10	510	68
RW21BPE	10	510	68
SEI5APB	N/A*	40	52
SEI5APBH	N/A*	40	52, 58
SEI7APBH	N/A*	40	52, 58
SEI9APB	N/A*	40	52
W3050YXS	5	250	45
W3075YXC	5	250	45
W3100YXC	5	250	45
W3125YXC	5	250	45
W3150YXC	5	250	45
ZX10EAA	12	576	23
ZX10EAAR	8	1728	23
ZX13EAA	12	576	23
ZX13EAAR	8	1728	23
ZX16EAA	10	360	23
ZX16EAAR	8	1728	23
ZX18EAA	10	360	23
ZX18EAAR	6	768	23
ZX21EAA	10	240	23
ZX21EAAR	6	768	23

Staples

Item Code	Boxes Per Carton	Boxes Per Skid	Page
A04BAAN	48	1152	63
A06BABN	6	216	63
A06BABP	8	192	63
A08BAB	12	288	63
A08BABP	8	192	63
A809909R	5	560	27
B04BAAPN	8	192	63
B06BAAP	4	96	63
B08BAAP	4	96	63
C02BAAPN	8	192	63
C03BAAPN	8	192	63
C03BGAN	8	272	63
C04BAAP	8	192	63
C04BAAR	6	480	63
C04BGAN	8	272	63
C05BAAPN	8	192	63
C06BAAP	4	96	63
C06BAAR	6	480	63
C06BGA	20	480	63
C06BHA	20	640	63
C07BAAPN	4	96	63
C08BAAP	4	96	63
C08BAAR	6	480	63
C10BAAP	4	96	63
C10BAAR	4	384	63
D10BABN	6	216	63
D10BABPN	8	192	63

Staples

Item Code	Boxes Per Carton	Boxes Per Skid	Page
E06BAA	20	640	64
E08BAA	16	512	64
E10BAA	25	800	64
F04BAAN	12	384	64
F04BAAP	8	192	64
F05BAAP	4	96	59, 64
F06BAA	10	300	59, 64
F06BAAP	4	96	59, 64
F06BGA	10	300	59, 64
F08BAAN	8	240	59, 64
F08BAAP	4	96	59, 64
G04BAAN	24	480	64
G06BABN	25	800	64
G08BAB	20	640	64
H06BAA	20	480	64
H06BAAPR	5	200	64
J06BAA	12	216	59
J08BAAN	9	288	59
J10BAAN	8	160	59
K11BAB	6	240	26
K12BAB	10	400	26
K13BABN	12	384	26
L06BAB	10	360	27
L07BABP	N/A*	112	27
L08BAB	8	288	27
L10BABN	12	432	27
L10BABR	6	672	27
L10BHA	12	432	27
L10HABN	12	432	27
L11BAB	10	360	27
L11BABR	6	672	27
L11BGA	10	360	27
L11BGBR	6	672	27
L11BRB	10	360	27
L11HAB	10	360	27
L11HBB	10	360	27
L12BAB	10	360	27
L12BQB	10	360	27
L13BABN	8	288	27
L13BABR	6	672	27
L13BRBN	8	288	27
L13BRBP	N/A*	36	27
L13HABN	8	288	27
L14BAB	6	216	27
L14BGA	6	216	27
L14BGBR	5	560	27
L14BRB	6	216	27
L15BAB	6	216	27
L15BABR	5	560	27
L15BRB	6	216	27
L17BAB	6	216	27
L17BABR	5	560	27
M06BABN	7	224	28
M08BAB	6	192	28
M10BABN	9	288	28
M10BRBN	9	288	28
M11BABN	8	256	28
M11BRBN	8	256	28
M12BAB	6	192	28
M13BAB	6	192	28
M13BRB	6	192	28
M15BAB	N/A*	60	28
M17BAB	N/A*	48	28
M004092	N/A*	180	53
N08BABN	6	192	28, 47, 65
N08BBBN	6	192	28, 47, 65
N08FBB	6	192	28, 47, 65
N10BAB	6	192	28, 47, 65
N11BAB	6	192	28, 47, 65
N11BRB	6	192	28, 47, 65
N11FBB	6	192	28, 47, 65
N12BABN	6	192	28, 47, 65
N12FABN	5	160	28, 47, 65

Staples

Item Code	Boxes Per Carton	Boxes Per Skid	Page
N13BAB	4	128	28, 47, 65
N13BRB	4	128	28, 47, 65
N13FAB	4	128	28, 47, 65
N14BAB	N/A*	56	28, 47, 65
N14BRB	N/A*	56	28, 47, 65
N15BAB	N/A*	56	28, 47, 65
N15BGB	N/A*	165	28, 47, 65
N15BRB	N/A*	56	28, 47, 65
N15FAB	N/A*	56	28, 47, 65
N16BAB	N/A*	56	28, 47, 65
N16BRB	N/A*	56	28, 47, 65
N17BAB	N/A*	48	28, 47, 65
N17BGB	N/A*	165	28, 47, 65
N17BRB	N/A*	48	28, 47, 65
N18BAB	N/A*	48	28, 47, 65
N18BRB	N/A*	48	28, 47, 65
N19BAB	N/A*	40	28, 47, 65
N19BGBN	N/A*	130	28, 47, 65
N19BRB	N/A*	40	28, 47, 65
N21BAB	N/A*	40	28, 47, 65
N21BGBN	N/A*	120	28, 47, 65
N21BRB	N/A*	40	28, 47, 65
P06BAA	N/A*	60	46
P08BABT	N/A*	60	46
P10BAB	N/A*	60	46
P10BPE	N/A*	60	46
P10FAB	N/A*	60	46
P11BAB	N/A*	50	46
P11BPE	N/A*	50	46
P12BAB	N/A*	40	46
P13BAB	N/A*	40	46
P13BABR	4	192	46
P13BGBN	N/A*	60	46
P13BPE	N/A*	40	46
P15BAB	N/A*	30	46
P15BABR	4	192	46
P15BPE	N/A*	30	46
P17BAB	N/A*	30	46
P19BAB	N/A*	40	46
P21BAB	N/A*	40	46
Q15BAB	N/A*	64	47
Q17BAB	N/A*	64	47
Q17BRB	N/A*	64	47
Q19BGBN	N/A*	130	47
Q19BRB	N/A*	64	47
Q21BAB	N/A*	56	47
Q21BRB	N/A*	56	47
Q23BRB	N/A*	48	47
Q25BAB	N/A*	48	47
Q25BRB	N/A*	48	47
R08BAB	12	384	26
R10BAB	12	480	26, 68
R11BAB	12	480	26, 68
R13BAB	12	480	26, 68
W10BAB	10	400	63
X04NRA	N/A*	224	29
X06NRA	N/A*	224	29
X08NRA	N/A*	224	29
Y05BFA	10	320	29
Y07BFA	8	256	29
Y09BFAN	6	180	29

*Product is shipped in the item box, not in a master shipping carton.

ITEM CODE INDEX

Screws

Item Code	Boxes Per Carton	Boxes Per Skid	Page
06A125P	6	144	8
06A125PB	N/A*	72	8
06A162P	6	144	8
06A162PB	N/A*	72	8
06A162W	6	144	8
06B125P	6	144	8
06B125PB	N/A*	72	8
06B162P	6	144	8
06B162PB	N/A*	72	8
06B200PB	N/A*	48	8
06C125CB	N/A*	72	8
06C125PB	N/A*	72	8
06C125WK	6	240	8
06C162CB	N/A*	72	8
06C162PB	N/A*	72	8
06C162WK	6	240	8
06C200CB	N/A*	48	8
06C200PB	N/A*	48	8
07A200P	6	144	8
07Q100PB	N/A*	72	9
07Q125PBQ	N/A*	72	9
08A250PK	6	192	8
08C300WK	6	144	8
08D175W	6	144	9
08D200W	6	144	9
08D250S	6	144	9
08D250W	6	144	9
08D250WK	6	192	9
08D300W	6	144	9
08D300WK	6	144	9
08F150Y	6	144	8
08F150YTK	6	240	8
08F175Y	6	144	8
08F175YTK	6	240	8
08F200Y	6	144	8
08F200YBTHSS	N/A*	48	8
08F200YTK	6	192	8
08F250Y	6	144	8
08F250YK	6	192	8
08F300Y	6	144	8
08G100CBWFDS	N/A*	72	9
08G150CTLDSS	6	144	9
08G162CTWFWS	6	144	9
08G200CKLFPS	6	192	9
08G200WTWFWS	6	144	9
08G250WWK	6	192	9
08L125CBLCTS	N/A*	72	8
08L175YB	N/A*	72	8
08M050CTRFDP	6	144	11
08M050CTRFSP	6	144	11
08M100CBPDSS	N/A*	72	11
08R250W	6	144	10
08R300W	6	144	10
08S250W003	6	144	10
08S250W497	6	144	10
08S250W592	6	144	10
08T125W	6	144	9
08T150WBWFDS	N/A*	72	9
08T200W	6	144	9
08X125CBACTS	N/A*	72	11
08X125CKADDS	6	240	11
08X200CKADDS	6	192	11
09D300S	6	144	9
10G125CBWFDS	N/A*	72	9
10G162CTWFWS	6	144	9
10M075CDK	6	240	11
10M075CSK	6	240	11
10M075CTMFDS	6	144	10
10M075YKFT4X	6	240	10
10M075YLFT4X	N/A*	48	10
10M075YTFDX	6	144	10
10M100CKMFDS	6	240	10
12G175YKLFAX	6	240	9

Screws

Item Code	Boxes Per Carton	Boxes Per Skid	Page
12G200YKLFAX	6	192	9
12G250YKLFAX	6	192	9
12M087YKFF4X	6	240	10
12M100YKFF3X	6	240	10

DURASPIN® Accessories

Item Code	Page
10X0002N	6
10X0012N	6
10X0022N	6
9Z0001N	5
9Z0011N	5
9Z0012N	5
9Z0021N	5
ADP009	12
ADP019	12
EA0297	12
EA0297N	12
EA0298	12
EA0298N	12
EA0299	12
EA0299N	12
EA0300	12
EA0301	12
EA0301N	12
EA0302	12
EA0308	12
EA0314	12
EA0315	12
EA0315N	12
EA0316	12
EA0316N	12
EA0396	12
EA0397	12
EA0400	12
EA0401	12
EA0402	12
FA0334	13
FB0155	13
FB0157	13
FB0159	13
FB0178	13
FB0185	13
FC0878	13
FC0895	13
FC0983	13
FC1022	13
FC1023	13
HA0332	13
MB0174	12
MB0183	12
MB0184	12
MB0185	12
MB0186	12
MB0187	12

Pneumatic Accessories

Item Code	Page
HA0308	51
HC0788	38
MA0013	51
NPC035	37
PC0051	75
PC0057	75
PC0064	73
PC0065	73
PC0101	76
PC0102	76
PC0103	76
PC0344	76
PC0349	75
PC0350	76
PC0351	76
PC0477	74
PC0478	74
PC0479	74
PC0480	74
PC0489	75
PC0501	74
PC0502	74
PC0503	74
PC0504	74
PC0505	74
PC0506	74
PC0576	74
PC0577	74
PC0629	76
PC0630	76
PC0643	75
PC0656	75
PC0657	75
PC0900	74
PC0977	73
PC0978	73
PC0979	73
PC0983	75
PC0987	75
PCI138	75
PCI152	73
PCI166	76
PCI295	76
PCI319	73
PCI320	73
PCI321	73
PCI322	73
PCI323	74
PCI325	74
PCI328	74
PCI330	74
PCI337	73
PCI338	73
PCI339	73
PCI340	73
PCI341	73
SWM125B	37
YB0123	76
YJ0042	33
YJ0043	33
YJ0044	37
YJ0055	33

No-Mar Pads









Item Code	Page
HA0170	77
HA0200	77
HA0201	77
HCO253	77
HCO396	77
HCO401	77
HCO463	77
HCO506	77
HCO507	77
HCO536	77
HCO571	77
HCO572	77
HCO625	77
HCO626	77
HCO729	77
HF0028	77
HF0029	77
HF0046	77
HF0064	77
HF0079	77
HF0110	77
HF0113	77

Extended Magazines

Item Code	Page
GA0767	31, 76
GA0778	31, 76

*Product is shipped in the item box, not in a master shipping carton.

DURASPIN® AUTO-FEED SCREW SYSTEMS

COLLATED SCREWS	DRYWALL	WOOD/WOOD	WOOD/STEEL	UNDERLAYMENT	DECKS & DOCKS	METAL/METAL	LOW PROFILE FRAMING	SPECIALTY
								
Pg. 8-11	Pg. 8	Pg. 8	Pg. 9	Pg. 9	Pg. 9-10	Pg. 10	Pg. 11	Pg. 11

CORDLESS INTEGRATED	DS225-18V	DS222-18V	DS322-18V
			
Pg. 3	Pg. 3	Pg. 3	Pg. 3

CORDED INTEGRATED	DS245-AC	DS242-AC	DS342-AC
			
Pg. 4	Pg. 4	Pg. 4	Pg. 4

SCREWDRIVER ATTACHMENTS	DS230-S1	DS230-M1	DS230-D1	DS230-D2
				
Pg. 5	Pg. 5	Pg. 5	Pg. 5	Pg. 5

SCREWDRIVER ATTACHMENT KITS	DS530 SERIES	DS532-AC KIT	DS534-AC KIT
			
Pg. 6	Pg. 6	Pg. 6	Pg. 6

SCREWDRIVERS	SG2510	SG4100
		
Pg. 7	Pg. 7	Pg. 7

FINISH & WOODWORKING

FINISH NAILS	F-15XP	FinishPro30XP	TN51P1P	FinishPro42XP
 				
Pg. 25	Pg. 15	Pg. 19	Pg. 19	Pg. 19

FINISH NAILS	F-16XP	TN41P1P
 		
Pg. 24	Pg. 15	Pg. 18

BRAD NAILS	F-18XP	LS1XP	BN31M1P	FinishPro18Mg
 				
Pg. 23, 24	Pg. 15	Pg. 17	Pg. 17	Pg. 17

FinishPro188Mg	SLP20XP	FinishPro25XP
		
Pg. 18	Pg. 18	Pg. 18

FINISH STAPLES	F-LXP	SLS20XP-L	SLS25XP-L
 			
Pg. 27	Pg. 15	Pg. 20	Pg. 20

SKSXP-L	SLS150Mg	LS61H1P
		
Pg. 20	Pg. 21	Pg. 21

FINISH & WOODWORKING

FINISH STAPLES			SLS20XP-M	SLS25XP-M	SKSXP-M	FINISH STAPLES		SLS20XP-K
 						 		
Pg. 28			Pg. 20	Pg. 20	Pg. 20	Pg. 26		Pg. 20

FINISH STAPLES		SLS20XP-R	MEDIUM PINS		TN21L1
 					
Pg. 26		Pg. 20	Pg. 23		Pg. 17

HEADLESS PINS		TN11G1	TN11L1	TN11G1P
 				
Pg. 23		Pg. 16	Pg. 16	Pg. 16

SENCLAMP®		SC1XP SENCLAMP®	SENCOR®		SC2 SENCOR®
 					
Pg. 29		Pg. 22	Pg. 29		Pg. 22

FRAMING, SHEATHING & SUBFLOORS

COIL NAILS		SCN60XP	SCN65XP	HEAVY WIRE STAPLES		SQS55XP
 						
Pg. 42-44		Pg. 35	Pg. 35	Pg. 47		Pg. 38





HEAVY WIRE STAPLES		SKSXP-N	NS20XP	NS20BXP	SNS41
 					
Pg. 47		Pg. 20	Pg. 38	Pg. 38	Pg. 38

FRAMING, SHEATHING & SUBFLOORS

HEAVY WIRE STAPLES	PS15XP	PS20XP
		
Pg. 46	Pg. 37	Pg. 37



PLASTIC COLLATED NAILS	F-35FRHXP	FN81T1	FramePro325FRHXP	FramePro702XP	FramePro752XP
					
Pg. 41-42	Pg. 31	Pg. 32	Pg. 34	Pg. 34	Pg. 34

PAPER TAPE NAILS	F-35XP	FN91T	FramePro325XP	FramePro701XP	FramePro751XP
					
Pg 39-40	Pg. 31	Pg. 32	Pg. 33	Pg. 33	Pg. 33

MINI HAND NAILER	A20 HAND NAILER	CONCRETE PINS	SCP40XP
			
Pg. 35	Pg. 35	Pg. 45	Pg. 37

METAL CONNECTOR NAILS	JN91H1	JN91H2	JN91P1	JN91P2
				
Pg. 45	Pg. 36	Pg. 36	Pg. 36	Pg. 36

ROOFING, SIDING & FENCING

ROOFING NAILS		RoofPro445XP	COIL NAILS		SN71P1
RF ROOFING			15° COIL		
Pg. 51		Pg. 49	Pg. 51-52		Pg. 49

HEAVY WIRE STAPLES		PS15RXP	FINE WIRE STAPLES		A11 HAMMER STAPLER
16 ^{GA} P			20 ^{GA} H		
Pg. 53		Pg. 50	Pg. 53		Pg. 50

CAP & STAPLES		BC58 CAP
CAP STAPLE		
Pg. 53		Pg. 50

PALLETS & CRATING

COIL NAILS	PALLETPRO57FXP	PALLETPRO100XP	PALLETPRO130XP
15° COIL			
Pg. 57-59	Pg. 55	Pg. 55	Pg. 55

FINE WIRE STAPLES		F75LXP	F75SXP	FINE WIRE STAPLES		DFPXP
18 ^{GA} J				20 ^{GA} F		
Pg. 59		Pg. 56	Pg. 56	Pg. 59		Pg. 56





UPHOLSTERY & FURNITURE

HEAVY WIRE STAPLES	NS20BXP
<div style="background-color: #8B4513; color: white; padding: 10px; display: inline-block; margin-bottom: 10px;">16^{GA} N</div> 	
Pg. 65	Pg. 62

FINE WIRE STAPLES	SFT10XP FAMILY
<div style="display: flex; justify-content: space-around; gap: 10px;"> <div style="background-color: #8B4513; color: white; padding: 5px; text-align: center;">20^{GA} E</div> <div style="background-color: #8B4513; color: white; padding: 5px; text-align: center;">20^{GA} F</div> <div style="background-color: #000080; color: white; padding: 5px; text-align: center;">20^{GA} G</div> </div> <div style="display: flex; justify-content: space-around; gap: 10px; margin-top: 10px;"> <div style="background-color: #000080; color: white; padding: 5px; text-align: center;">22^{GA} A/D</div> <div style="background-color: #008080; color: white; padding: 5px; text-align: center;">22^{GA} B</div> <div style="background-color: #FF00FF; color: white; padding: 5px; text-align: center;">22^{GA} C</div> </div> 	
Pg. 63, 64	Pg. 61

FINE WIRE STAPLES	SFW09
<div style="background-color: #FF00FF; color: white; padding: 10px; display: inline-block; margin-bottom: 10px;">22^{GA} C</div> 	
Pg. 63	Pg. 62

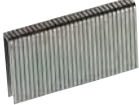
FLOORING

FLOORING CLEATS	SHF200	FLOORING STAPLES	SLS20XP-HF
<div style="background-color: #A9C9C9; color: white; padding: 10px; display: inline-block; margin-bottom: 10px;">FC FLOORING CLEATS</div> 		<div style="background-color: #4B0082; color: white; padding: 10px; display: inline-block; margin-bottom: 10px;">19^{GA} R</div> 	
Pg. 68	Pg. 67	Pg. 68	Pg. 67

AIR COMPRESSORS & KITS

PC1131	PC0968	PC1280	PC1010	PC1010N	PC0947 KIT
					
Pg. 71	Pg. 71	Pg. 71	Pg. 71	Pg. 71	Pg. 71

KYOCERA SENCO Industrial Tools, Inc.

Looking for more?



Contact Us

8450 Broadwell Road
Cincinnati, Ohio 45244

Phone: 800.543.4596
Fax: 800.543.3299



Visit Us

On the web for more information
SENCO.com



Find Us

Search for your closest SENCO dealer
SENCO.com/dealer-locator/



Watch Us

Check out all of our latest videos & product launches
Youtube.com/SencoBrands



Follow Us

instagram.com/SencoBrands
facebook.com/SencoBrands
twitter.com/Senco

SENCO[®]

MAKING HARD WORK EASIER

Item #MK336

©2024 KYOCERA SENCO Industrial Tools, Inc.